

RADIO-CRAFT

HUGO GERNSBACK, *Editor*

REVOLVING WIRE TAPE

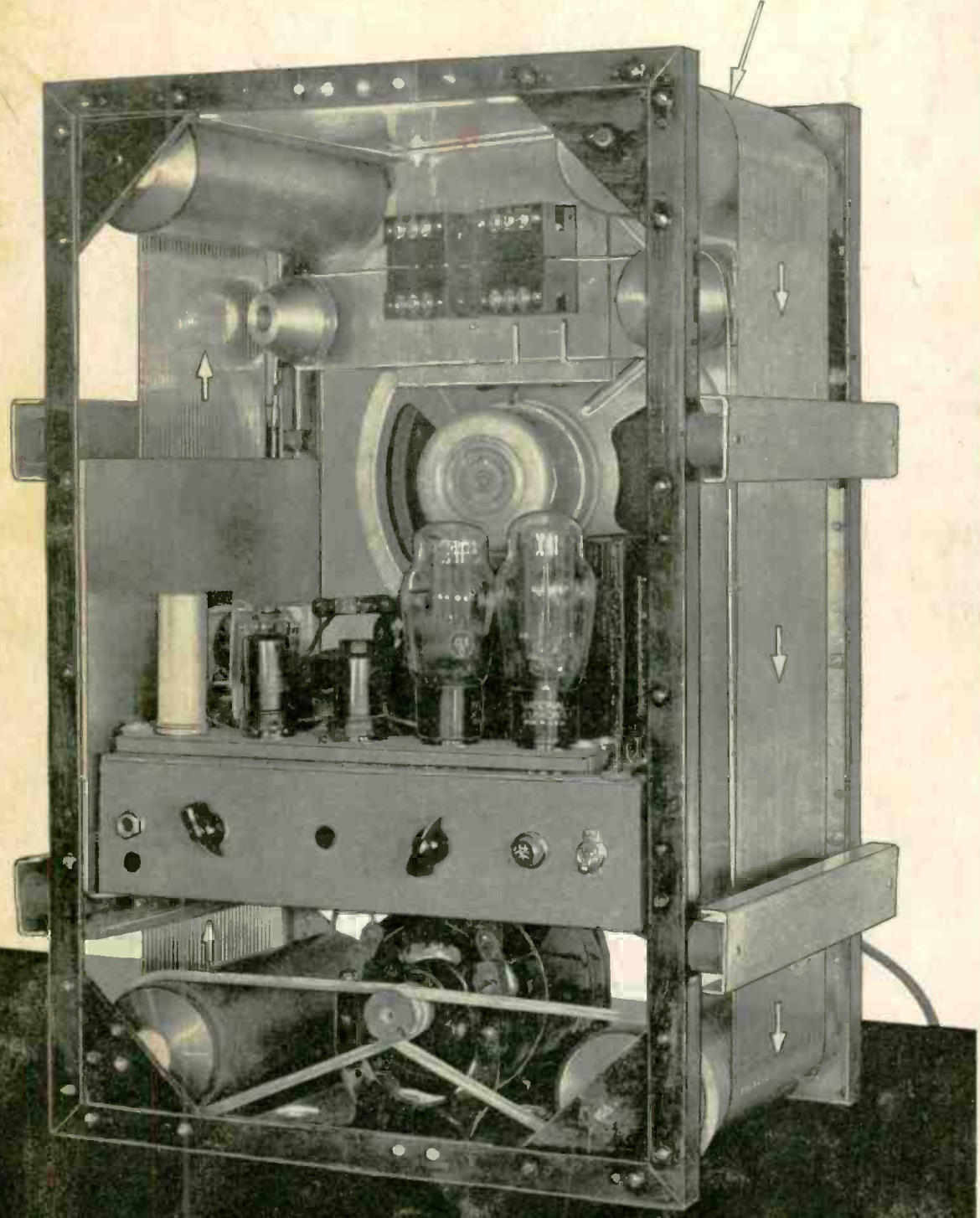

SOUND ON WIRE TAPE!

See Page 654

★
Announcing-
\$4,000⁰⁰
PUBLIC ADDRESS
CONTEST
★

DETAILS PAGE 648



RADIO PERSONIFIED

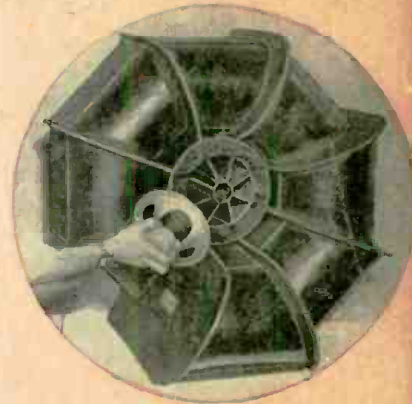

SPEAKER BAFFLE

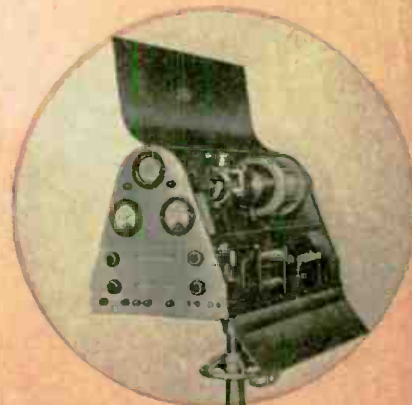

TELEVISION PROJECTOR

MAY RADIO'S GREATEST MAGAZINE!
25c P.A. SPEAKER PLACEMENT • A 5-WATT AMPLIFIER
IN U. S. AND CANADA **48 NEW TUBES! • INTERMODULATION DISTORTION**

Now...

5 VITAL FEATURES COMBINED AND UNIFIED IN THE AMPERITE VELOCITY WITH ACOUSTIC COMPENSATOR

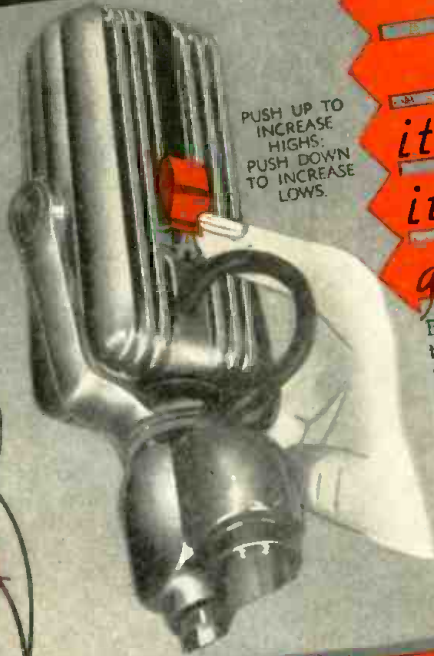
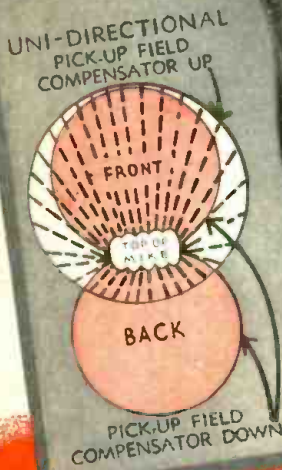

PUSH UP TO INCREASE HIGHS; PUSH DOWN TO INCREASE LOWS.

- it's a VELOCITY
- it's a DYNAMIC
- it's UNI-DIRECTIONAL
- it's NON-DIRECTIONAL
- gives HIGH OR LOW PITCH

By moving up the Acoustic Compensator, you change the Amperite Velocity Microphone to dynamic operation—without peaks. At the same time you reduce the back pickup, making the microphone practically uni-directional. With the Acoustic Compensator down, the microphone is bi-directional... 120 degrees front and back without frequency discrimination. Rotating the microphone until it parallels the ceiling makes the microphone non-directional. THE ACOUSTIC COMPENSATOR is a regular feature of these models: RBHk (hi-imp); RBMk (200 ohms) LIST \$42.00. RSHk (hi-imp); RBSk (200 ohms), \$32.00 LIST



FOR TOP-NOTCH QUALITY,
AND AMAZING RUGGEDNESS,
AT LOW COST
Specify Model RAH (or RAL).

Here's why this popular Amperite Velocity Microphone leads the low-price field: (1) it is excellent for both speech and music; (2) has flat response without undesirable peaks; (3) reduces feedback; (4) stands up under rain, wind, heat, and rough handling. ... Frequency range 60 to 7500 CPS. Output, -68 db. MODEL RAH (hi-imp), with 12' of cable; MODEL RAL (200 ohms), with 8' of cable. ... \$22.00 LIST.



SELL "CONTACT MIKES" to Professional and Amateur Musicians. New high output model can be used in the home.

Professional musicians are buying Amperite "Contact Mikes" because "it makes an ordinary violin sound like a Strad." Now amateurs, too, can benefit by the "Contact Mike." The new HIGH OUTPUT MODEL SKH can be used in the home. It operates on most radio sets made since 1935. It is connected to the phono-input, or to grid ground of detector tube, or across the volume control. Note new clamp, making the mike easy to attach to guitars, ukes, etc. MODEL SKH (hi-imp); SKL (200 ohms) \$12.00 LIST. Any number up to 5 SKH's can be put in parallel and fed into one input. NEW FOOT PEDAL, \$12.00 LIST. CLAMP for Contact Mike, \$1.00 LIST.

Sales Aids for the P. A. Man

- (1) FREE Window Decal advertising your Sound Service. Size 5 1/4 x 9 1/4, finished in 4 colors.
- (2) FREE Window Display, 11 x 17.
- (3) Special Sound Equipment Letterheads, Samples and prices on request.
- (4) FREE use of cut for printing business cards, etc.

AMPERITE ©, 561 BROADWAY, N. Y., U. S. A. CABLE ADDRESS ALKEM, NEW YORK

"Better Systems Specify Amperite"



VELOCITY **AMPERITE** MICROPHONES

Read what happened



YES!

I'll take your training. That's what S. J. Ebert said. He is making good money and has found success in Radio.

to these
two men

when I said:



NO!

I'm not interested. That's what this fellow said. Today he would be ashamed if I gave you his real name and salary.

I will Train You at Home in Spare Time for a GOOD JOB IN RADIO

These two fellows had the same chance. Each sent me a coupon, like the one in this ad. They got my book on Radio's opportunities. S. J. Ebert, 104-B Quadrangle, University of Iowa, Iowa City, Iowa, saw Radio offered him a real chance. He enrolled. The other fellow, whom we will call John Doe, wrote he wasn't interested. He was just one of those fellows who wants a better job, better pay, but never does anything about it. But read what S. J. Ebert wrote me: "Upon graduation I accepted a job fixing Radio sets. Within three weeks I was made Service Manager. This job paid me \$40 to \$50 a week compared with \$18 I earned in a shoe factory before. Eight months later I went with station KWCR as operator. From there I went to KTNT. Now I am Radio Engineer with WSUI. I certainly recommend the N. R. I. to all interested in the greatest field of all, Radio."

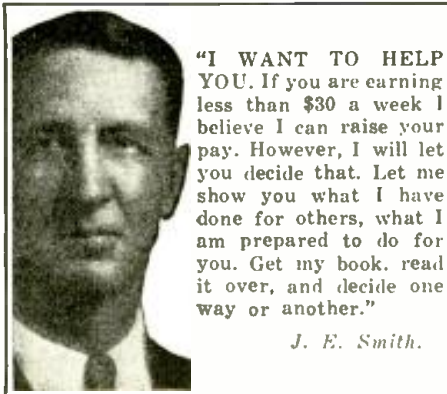

"I WANT TO HELP YOU. If you are earning less than \$30 a week I believe I can raise your pay. However, I will let you decide that. Let me show you what I have done for others, what I am prepared to do for you. Get my book, read it over, and decide one way or another."

J. E. Smith.

I Also Give You This Professional Servicing Instrument

Here is the instrument every Radio expert needs and wants—an All-Wave, All-Purpose, Set Servicing Instrument. It contains everything necessary to measure A.C. and D.C. voltages and current; to test tubes, resistance; adjust and align any set, old or new. It satisfies your needs for professional servicing after you graduate—can help you make extra money fixing sets while training.



You Are Trained for Television Also

With N.R.I. you take up Television principles right along with Radio principles—the correct method—since Television receivers combine both sight and sound. You also get more than ten text books devoted entirely to Television.

Find Out What Radio Offers You

Act Today. Mail the coupon now for "Rich Rewards in Radio." It's free to any fellow over 16 years old. It points out Radio's spare time and full time opportunities and those coming in Television; tells about my training in Radio and Television; shows you letters from men I trained, telling what they are doing and earning. Find out what Radio offers YOU! MAIL COUPON in an envelope, or paste on a postcard—NOW!

J. E. SMITH, President
Dept. 9EX, National Radio Institute
Washington, D. C.



Many Radio Experts Make \$30, \$50, \$75 a Week

Radio broadcasting stations employ engineers, operators, station managers and pay well for trained men. Fixing Radio sets in spare time pays many \$200 to \$500 a year—full time jobs with Radio jobbers, manufacturers and dealers as much as \$30, \$50, \$75 a week. Many Radio Experts open full or part time Radio sales and repair businesses. Radio manufacturers and jobbers employ—testers, inspectors, foremen, engineers, servicemen, in good-pay jobs with opportunities for advancement. Automobile, police, aviation, commercial Radio, loud speaker systems are newer fields offering good opportunities now and for the future. Television promises to open many good jobs soon. Men

I trained have good jobs in these branches of Radio. Read how they got their jobs. Mail coupon.

Many Make \$5, \$10, \$15 a Week Extra in Spare Time While Learning

The day you enroll I start sending Extra Money Job Sheets; show you how to do Radio repair jobs. Throughout your training I send plans and directions that made good spare time money—\$200 to \$500—for hundreds, while learning. I send you special Radio equipment to conduct experiments and build circuits. This 50-50 method of training makes learning at home interesting, fascinating, practical. I ALSO GIVE YOU A MODERN, PROFESSIONAL ALL-WAVE, ALL-PURPOSE RADIO SET SERVICING INSTRUMENT to help you make good money fixing Radios while learning and equip you for full time jobs after graduation.

Get My Lesson on Radio Servicing Tips FREE

I'll prove my Training gives practical, money-making information; is easy to understand—is just what you need to master Radio. My sample lesson text "Radio Receiver Troubles—Their Cause and Remedy" covers a long list of Radio receiver troubles in A.C., D.C., battery, universal, auto, T.R.F., super heterodyne, all-wave, and other types of sets and a cross reference system gives you the probable cause and a quick way to locate and remedy these set troubles. A special section is devoted to receiver check-up alignment, balancing, neutralizing and testing. Get this lesson free. No obligation. Just mail coupon.



FOR FREE BOOK OF FACTS ABOUT RADIO

J. E. SMITH, President, National Radio Institute
Dept. 9EX, Washington, D. C.

Without obligating me, send your service manual "Radio Receiver Troubles—Their Cause and Remedy" and free book about spare time and full time Radio opportunities and how I can train for them at home in my spare time and about the N.R.I. Set Servicing Instrument you give me.

I am particularly interested in the branch of Radio checked.

- Radio Service Business of My Own
- Spare Time Radio Service Work
- Retail Sales of Radio Sets and Equipment
- Broadcasting Station Operator
- Aviation Radio Operator
- Auto Radio Installation and Service
- All-around Servicing Expert
- Loud Speaker Systems, Installation and Service
- Television Station Operator
- Service Expert with Radio Factory
- Commercial Radio Station Operator

(If you have not decided which branch you prefer—mail coupon now, for information to help you decide.)

NAME AGE

ADDRESS 14X-1

Please Say That You Saw It in RADIO-CRAFT

RADIO-CRAFT

HUGO GERNSBACK, *Editor-in-Chief*

N. H. LESSEM
Associate Editor

THOS. D. PENTZ
Art Director

ROBERT EICHBERG
Trade Digest Editor

R. D. WASHBURNE, *Managing Editor*

Contents MAY, 1939 Issue

VOLUME X -- NUMBER 11

Editorial: Radiobservations.....	Hugo Gernsback	645
The Radio Month in Review.....		646
\$4,000 Public Address Contest.....		648
How to Build a High-Fidelity 5-Watt Versatile Amplifier	H. S. Manney	649
Emergency Network Patrols State Highways.....		650
Intermodulation and Its Relation to Distortion.....	A. C. Shaney	652
Sound-on-Wire Tape! (Cover Feature).....	R. D. Washburne	654
48 New Tubes.....	R. D. Washburne	656
D.C. to A.C. Conversion Using Polarity Changers....	William Garstang	660
Complete Step-by-Step Dynamic Servicing—Part V....	Kendall Clough	662
New Circuits in Modern Radio Receivers—No. 20....	F. L. Sprayberry	663
An "Octave-Resonance" Multiple Air-Column Baffle....	Wm. R. Allison	664
A Chandelier Speaker Baffle.....	R. C. Reinhardt	666
Operating Notes		667
Servicing Questions & Answers.....		667
Speaker Placement in Public Address Work.....	H. W. Paro	668
The Latest Radio Equipment.....		670
RADIO SERVICE DATA SHEETS:		
No. 252—Emerson Models AX-211, AX-212, AX-217, AX-235, AX-237, AX-238, AX-239, AX-240 (Chassis Model AX)		672
No. 253—International Kadette A.C.-D.C. Model KRC-2 "Tunemaster"		673
A Modern Rod Antenna.....	Charles F. Jacob	674
Radio Trade Digest.....		675
Book Reviews		643

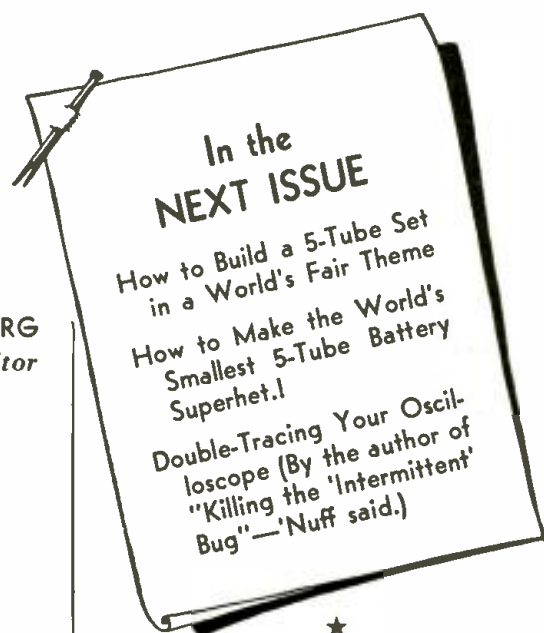

★

BULLETIN

SORRY—No "Special Catalog Num-
ber" this issue.

Due to the fact that the annual
Radio Parts Show is so close at
hand (June) manufacturers find it
inconvenient to cooperate with us
at this time inasmuch as they are
preparing new catalogs for the
Show. We find it necessary, there-
fore, to put off, indefinitely, pub-
lication of the previously-announced
"Special Catalog Number."

★

Published by Radcraft Publications, Inc.
Publication office: 29 Worthington Street,
Springfield, Mass. Editorial and Advertising
Offices: 99 Hudson Street, New York City.
Chicago Advertising Office: RADIO-
CRAFT, 520 North Michigan Avenue, Chi-
cago, Ill.

RADIO-CRAFT is published monthly, on
the first of the month preceding that of
date; subscription price is \$2.50 per year
in U. S. and Canada. (In foreign countries,
\$3.00 a year to cover additional postage.)
Entered at the post office at Springfield as
second-class matter under the act of
March 3, 1879.

Foreign Agents:

London—Gorrings American News Agency,
9A Green St., Leicester Square, W. C. 2, Eng-
land.

Paris—Messageries Dawson, 4 Rue Faubourg,
Poissonniere, France.

Melbourne—McGill's Agency, 179 Elizabeth
St., Australia.

Dunedin—James Johnston, Ltd., New Zealand.

★

Text and illustrations of this magazine are
copyright and must not be reproduced
without permission of the copyright owners.

★

Copyright 1939 Radcraft Publications, Inc.

RADIO-CRAFT

“RADIO'S GREATEST MAGAZINE”

RADIOOBSERVATIONS

By the Editor — HUGO GERNSBACK

PORTABLE RADIO SETS are nothing new in Radio. We have had them ever since the beginning of radio and even in the old days when radio still was “wireless.” When the first radio vacuum tubes made their appearance, portable radio sets with battery power were a novelty for some time but the public soon lost interest.

Twenty years afterwards, the portable radio receiver suddenly breaks out into a rash all over the country and as this is written there is a minor boom in this type of set. Self-contained, the modern portable radio receiver requires no aerial or ground of any kind and in this respect is ahead of the old-time receiver which required at least a fair-size loop antenna. In addition, the present-day portable uses a radio tube which consumes extremely small amounts of power and enables the batteries in the set to last over long periods of time. Yet, even good as such sets are, they are in my opinion, still not the ideal to be achieved.

Reason is that these sets still weigh anywhere from 20 to 30 pounds—much too great a weight for an ideal portable. When we get down to about 5 or 6 pounds—a not impossible figure—we will have a receiver of much greater popularity than the ones made now. In my opinion such sets can be constructed even now. These light-weight portable sets do not require the great loudspeaker power of the present portables; which means less tubes, smaller loudspeakers and smaller batteries also. I believe that there is a tremendous market for such a light-weight portable receiver.

* * *

One of the shortcomings in radio today is a rather odd one which does not often become apparent.

There is a tremendous amount of good and interesting radio programs on the air today. Few people in our complex civilization, where time is at a premium, find it possible to read the newspapers and follow all the programs of even one station throughout the day and evening. Even if they did, it is doubtful that they would remember every program. Then on top of all this, most newspapers do not give enough information about radio programs. Often, the program information printed in some newspapers is directly misleading or if not misleading, it furnishes an erroneous conception of what the program is all about. Then, many newspapers only print the network programs. In certain sections of the country, many newspapers do not print radio programs at

all, because radio is anathema, for, their owners believe that radio competes with the newspapers. All of this makes for a condition where half of the world never knows what the other half is doing, with respect to radio programs. To be sure, some of the larger stations announce their complete program once or twice a day. This however, is confined only to the particular station. So, if you happen to listen in to that station at the right time you may get an idea as to what programs will be on the air for the rest of the day.

But, you can not very well listen in to 6 or more local stations to find out what programs are on the air. It would consume too much time. On the other hand, it is certain that among all of the local stations there are always a number of features that you normally never hear or have a chance to hear, *simply because you do not know that these programs are on the air*. When it comes to very important broadcasts, these are usually given publicity by the newspapers but others which may be only *important to you* and to no one else, are never mentioned and may not even be mentioned by the stations themselves until the feature is actually on the air.

This is a rather deplorable condition that so far has baffled radio station owners and radio investigators alike. We cannot expect that station “A” which competes with station “B” would announce what programs there will be on the other station and vice-versa. It would seem, that for the good of radio there should be an independent organization which would make it its business to see to it that an intelligent, *complete* program service was to be given to listeners. This could be done in several ways.

A. A special organization would broadcast, 3 or 4 times a day, the programs of all local stations that will be on the air for the rest of the day over *all local stations*.

B. The same service could be rendered by this special organization by means of the new Facsimile radio, so radio listeners could get a printed program once or twice a day giving *all* of the programs for the day for *all* the stations.

C. Both services could be rendered so that listeners would get the information not only by ear but by sight as well.

Radio broadcasters are interested in educating listeners to listen-in as much as possible, and by giving a service of this type, it would benefit all of the broadcasters. It is a problem that requires considerable thought and study but is not insoluble.

THE RADIO MONTH



THE TELEDIRECTRESS
The National Broadcasting Co. last month appointed Miss Thelma A. Prescott as "television's first woman program director."

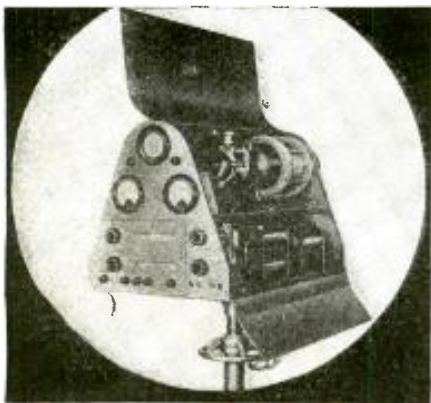

TELEVISION PROJECTOR
The Radio-Press-Service illustration shown above, and on the cover of this issue of *Radio-Craft*, depicts the new Lorenz A.G. television projector shown recently at the Berlin Radio Exhibition. These units, by means of a cathode-ray tube and a lens system, project an image of about 20 x 24 ins.

TELEVISION

MAX GORDON, noted producer of Broadway hits, will advise and assist the National Broadcasting Company in the production of television programs, it was announced last month.

On opening date last month, more than 12,000 persons attended the première of the RCA television show at San Francisco's Golden Gate International Exposition. One person in every 12, in passing before the lens of the television camera (at the rate of 15 persons-per-minute for 12 hours), participated in the television demonstrations.

JOHN LAW

"**G**OOD MORNING, Judge," said 7 youths last month after John Law terminated their short career of robbery which, up to that time, had netted \$11,000 in swag. A favorite radio program had shown them, they said, "how it could be done." But they must have missed the line that probably closed each presentation of the program—"CRIME DOES NOT PAY."

This incident shows that although some programs may have exceptional

entertainment value for certain groups, they may unduly influence other, more impressionable persons; hence, broadcasters must continually be on guard to maintain a program balance which does not over-step the bounds of the public's best interests.

La Science et la Vie, Paris, last month reported the case of a lawsuit in Hamburg, in which a group of truck farmers were fined for having managed to light the premises by utilizing the energy of programs transmitted by the Hamburg broadcast station. Plaintiff claimed an annual 5% loss of power (value, \$12,500 marks per year).

The fact of the matter is that whether a receiver is tuned to a transmitter or it isn't makes no appreciable difference in the performance of the transmitter! The truck farmers let the Hamburg-ers get away with veritable "murder."

Secret broadcasts came into considerable prominence in the press last month. For instance, the case of the roaming anti-Nazi broadcasts that the Russians placed in Germany, and vice versa, as recently mentioned in *Radio-Craft*, seems to have had finis written after it with the life sentence to the penitentiary of Ernst Neikisch. He is credited with having disseminated the "bootleg" radio propoganda from a secret, mobile radio station that broadcast from within the borders of Germany a series of attacks on the Nazi regime, according to a *United Press* report from Berlin.

M. M. Voznesensky, only Soviet radio operator in Russia's farthest north radio station, 560 miles from the North Pole, admitted to charges of sabotage to the extent of having failed to forward weather reports to Soviet Russian airmen on a flight over the North Pole from Moscow to the United States in 1937. The airmen later disappeared. Operator Voznesensky's seemingly reasonable plea that he had far too much work to do did not save him from a 20-year sentence to imprisonment, newspapers reported last month.

Press reports last month credited John Amen, special prosecutor, as having rescinded a previous request to N.Y.C. authorities for a "wiring device" in his private office to record the conversations of witnesses who come there to speak in confidence." Stated columnist Leonard Lyons: "The deal fell through because such an expenditure would have to be recorded in the *City Record*—and so witnesses would know of the device."

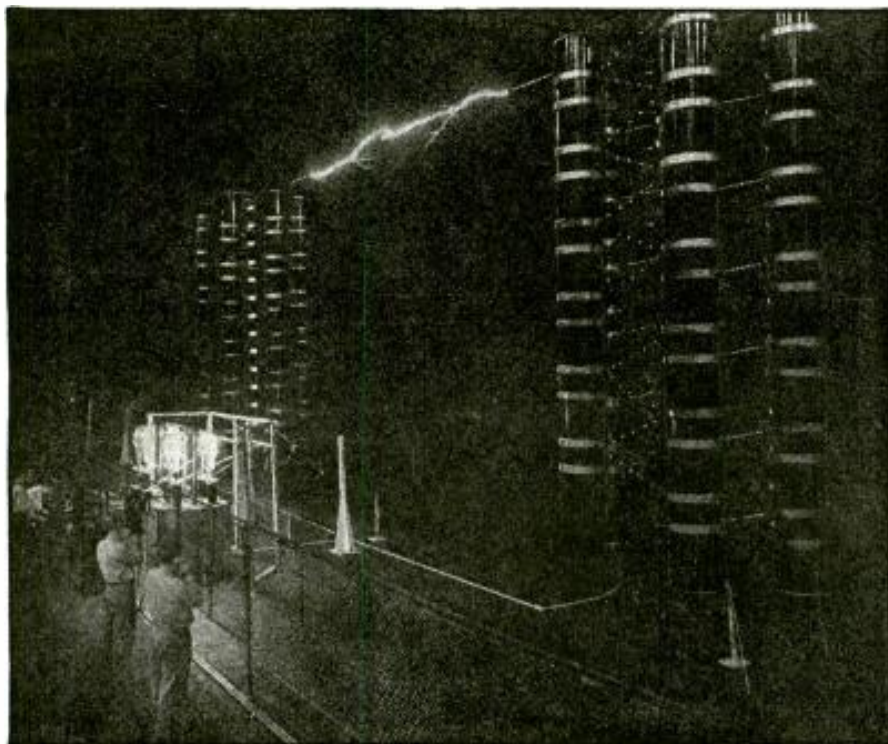

NEW YORK WORLD'S FAIR 1939
This streamlined lightning maker, here shown belching forth 10,000,000 V. of artificial lightning, will hurl thunderbolts across a 30-ft. gap in Steinmetz Hall, a part of the G.E. exhibit at the New York World's Fair, with a roar not unlike that of natural thunder. This will be the first public demonstration ever made of man-made lightning.

BOOK REVIEWS

RADIO-FREQUENCY ELECTRICAL MEASUREMENTS, by Hugh A. Brown (2nd Edition, 1938). Published by McGraw-Hill Book Co., Inc. Size, 6 x 9 ins., cloth cover, 384 pages, profusely illustrated. Price \$4.00.

In his preface to this 2nd edition the author points out that its contents departs from the preceding one in that exact instructions for the procedure to be followed in making the most difficult measurements are given. The book should prove to be a useful, ready manual for the practicing engineer.

This book may be used as a convenient manual and guide for the technically minded amateur also; and he should find no difficulty in following the instructions, even though he wishes to omit analyses and discussions of theory. Many non-mathematical explanations are given for the benefit of those who are always interested in why certain fundamentals are true.

Chapter headings follow: Measurements of Circuit Constants; Measurements of Frequency; Antenna Measurements; Electromagnetic-Wave Measurements; Measurement of Electron-Tube Coefficients and Amplifier Performance; Electromotive Force, Current, Power; Measurement of Wave Form; Modulation, Receiver and Piezo-Electric Crystal Measurements.

ENGINEERING ELECTRONICS, by Donald G. Fink (1938). Published by McGraw-Hill Book Co. Size 6 x 9, 197 illustrations, 299 pages. Price \$3.50.

This book, by two engineers of the Research Division of RCA and dedicated to Keith Henney, has been prepared with the cooperation of several companies, including General Electric, RCA, Westinghouse, Western Electric, etc. Important data on electronic fundamentals were supplied by professors of the University of California, John Hopkins, and the California Institute of Technology. In writing this book, the author has attempted to steer a course between simple descriptions of equipment on the one hand and elaborate technicalities on the other.

The book has been divided into 3 sections: Physical Electronics, Electron Tubes, and Electron-tube Applications.

Following is the list of contents: Electronics in Engineering—A Preliminary Survey; The Fundamental Properties of the Electron; Emission, the Production of Free Electrons; The Control of Free Electrons in a V. Cuum; Electron Currents in Gases & Vapors; Thermionic Tubes; Gas-filled Thermionic Tubes; Photosensitive Tubes and Cells; Electronic Sources of Light; Specialized Electron Tubes; Elements of Circuit Theory as Applied to Electron Tubes; and Circuits for Power Transformation, Electronic Communication, and Industrial Control and Measurement.

THE RADIO NOISE REDUCTION HANDBOOK. Published by Radio, Ltd. (1938). Size 6 x 9 ins., paper covers, 50 illustrations, 45 pages. Price 35c.

Due to the lack of space in Radio-Craft we were unable to publish sooner a review of this book which was released some time ago; however, that does not change the fact that its contents are noteworthy.

The book is not only of interest to Service men who want to incorporate in sets and installations on which they are working some form of anti-noise equipment which will be effective on all wavelengths, but also, set builders who may want to build into experimental receivers circuit variations which may accomplish this result. Numerous circuits are included; in most cases these are complete with the values necessary to aid the experimenter to duplicate the set-up.

Chapter headings follow: Radio Noise Suppression; Noise Balancing Systems; Noise Limiters; Suppressing Noise at Its Source; Analyzing the Type of Interference; Miscellaneous New Circuits.

TUBE COMPLEMENT BOOK WITH I.F. PEAKS (First Edition, 1938). Published by Hygrade Sylvania Corp. Pocket size (4½ x 9 ins.), paper covers, 168 pages, one illustration. Price 25c.

This book is not only a valuable guide to Servicemen, but also an interesting historical résumé of radio. Partial index: Alignment Precautions; Interchangeable Tubes; Receiver Manufacturers (Names and Addresses); Standard Panel or Dial Light Bulbs; Substituting New Types for Older Tubes; Tube Testers and Tube Testing; Trade Names of Receivers; Tubes Required for Replacement; Tube Complements with I.F. Peaks by Companies (about 350 companies).



QUICK, EASIER WAY
To TRAIN FOR
ELECTRICITY
12 Weeks *Practical WORK*
IN MY CHICAGO SHOPS



FIRST—You are told and shown how to do it. THEN—You do the job yourself.

WANT TO EARN MORE MONEY?

Have you ever dreamed of holding down a steady, good pay job? Have you ever dreamed of doing the work you really like in a job that holds promise of a real future in the years ahead?

Well, we all know that you can't get the good things in life by just dreaming about them. Hundreds of fellows are today holding down mighty fine jobs with prospects of a bright future. They are filling these jobs because they had the foresight to equip themselves with the right kind of training. Most of these men were only average fellows a short time ago, but the proper training helped to lift them out of the low pay ranks of unskilled workers. The same opportunity is now offered to you. The \$5,000 and \$10,000 a year men of the future will be those who are preparing and planning now. The great fascinating fields of **ELECTRICITY** and **Radio** offer a real future to many men and young men who are willing to prepare for a place in this giant industry.

AN EXTRA 4 WEEKS COURSE IN RADIO INCLUDED

Here at my school in Chicago the world's Electrical Center, you can get 12 weeks' Shop Training in Electricity and an Extra 4 weeks course in Radio at No Extra Tuition Cost, that can help give you your start towards a better job.

You will be trained on actual equipment and machinery and because of our method of training, you don't need previous experience or a lot of education. Many of my successful graduates never even completed Grammar School.

Here in my school you work on generators, motors, dynamos, you do house wiring, wind armatures and do actual work in many other branches of electricity and right now I'm including valuable instruction in Diesel, Electric Refrigeration and Air Conditioning at no extra cost. Our practical shop methods make it easier to learn—First the instructors tell you how a thing should be done—then they show you how it should be done—then you do the actual work yourself.



HOUSE WIRING
 Only one of the many branches you "Learn By Doing."



"... Everything was just as stated in literature. And by Coyne met a lot of plenty of instructors to take care of everything easy to learn. I really was satisfied with Coyne training."
 — J. Halley, Canada

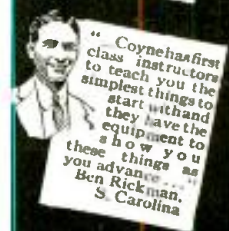

"Coyne has first class instructors to teach you the simplest things to start with and they have the equipment to show you these things as you advance."
 — Ben Rickman, S. Carolina



I'LL FINANCE YOUR TRAINING

You can get this training first—then pay for it later in easy monthly payments, starting 60 days after your 12 weeks' training period is over—then you have 12 months to complete your payments.

If you need part time work to help out with expenses while training in my shops, my employment department will help you get it. Then after graduation this department will give you valuable lifetime employment service.

Send the coupon today for all details. When I get it I'll send you my big free book containing dozens

of pictures of students at work in my shops. I'll also tell you about my "Pay After Graduation" plan, how many earn while learning and how we help our students after graduation. Fill in, clip coupon, mail today for your start toward a brighter future.



H. C. LEWIS, President,
COYNE ELECTRICAL SCHOOL,
 500 S. Paulina Street, Dept. 59-78,
 Chicago, Ill.

Dear Sir: Please send me free your big catalog and full particulars of your present offer; also your "Pay-Tuition-After-Graduation" Plan and your Extra 4 weeks Radio Course.

H. C. LEWIS, President
COYNE
ELECTRICAL SCHOOL
 500 S. Paulina St., Dept. 59-78, Chicago

NAME.....
 ADDRESS.....
 CITY.....STATE.....

Please Say That You Saw It in RADIO-CRAFT

For Better Servicing - - For Bigger Profits - - Use Gernsback Manuals and Books!



SINCE 1931 Servicemen have been buying more GERNSBACK OFFICIAL RADIO SERVICE MANUALS year after year. The authentic material, easily accessible diagrams and complete service data make them invaluable to dealers and radio Servicemen. *Without a Gernsback Service Manual at the repair job, there's time and profit lost.* Your service kit or laboratory is incomplete without all the GERNSBACK OFFICIAL RADIO SERVICE MANUALS. There are GERNSBACK MANUALS for servicing auto-radios, also refrigeration and air conditioning equipment.

- VOLUME 7 OFFICIAL RADIO SERVICE MANUAL**
Over 1,800 Pages • Over 3,000 Illustrations • Stiff, Leatherette, Looseleaf Covers • Size 9 x 12 Inches • Net Weight 10½ lbs. **\$10.00**
- 1936 OFFICIAL RADIO SERVICE MANUAL**
Over 1,200 Pages • Over 2,500 Illustrations • Stiff, Leatherette, Looseleaf Covers • Size 9 x 12 Inches • Net Weight 8 lbs. **\$7.00**
- 1935 OFFICIAL RADIO SERVICE MANUAL**
Over 1,000 Pages • Over 3,000 Illustrations • Flexible, Leatherette, Looseleaf Covers • Size 9 x 12 Inches • Net Weight 3¾ lbs. **\$7.00**
- 1935 OFFICIAL AUTO-RADIO SERVICE MANUAL**
Over 240 Pages • Over 500 Illustrations • Flexible, Leatherette, Looseleaf Covers • Size 9 x 12 Inches • Net Weight 1¾ lbs. **\$2.50**
- 1934 OFFICIAL RADIO SERVICE MANUAL**
Over 400 Pages • Over 2,000 Illustrations • Flexible, Leatherette, Looseleaf Covers • Size 9 x 12 Inches • Net Weight 2¼ lbs. **\$3.50**
- 1932 OFFICIAL RADIO SERVICE MANUAL**
Over 1,000 Pages • Over 2,000 Illustrations • Flexible, Leatherette, Looseleaf Covers • Size 9 x 12 Inches • Net Weight 4¾ lbs. **\$5.00**
- OFFICIAL REFRIGERATION SERVICE MANUAL (Volume I)**
Over 450 Pages • Over 1,200 Illustrations • Flexible, Leatherette, Looseleaf Covers • Size 9 x 12 Inches • Net Weight 2½ lbs. **\$5.00**
- OFFICIAL REFRIGERATION SERVICE MANUAL (Volume II)**
Over 352 Pages • Over 300 Illustrations • Flexible, Leatherette, Looseleaf Covers • Size 9 x 12 Inches • Net Weight 1½ lbs. **\$5.00**
- OFFICIAL AIR CONDITIONING SERVICE MANUAL**
Over 352 Pages • Over 600 Illustrations • Flexible, Leatherette, Looseleaf Covers • Size 9 x 12 Inches • Net Weight 2¼ lbs. **\$5.00**

To order these famous Manuals, see or write to your jobber or favorite mail order house. If more convenient, mail coupon directly to publishers.

RADCRAFT PUBLICATIONS, Inc.
99 HUDSON STREET NEW YORK, N. Y.

Get into the swing of reading instructive, authoritative books on technical subjects—radio, air conditioning and refrigeration. It's the easiest, quickest and most inexpensive way to improve your knowledge on these topics. In this series, popularly known as the RADIO-CRAFT LIBRARY SERIES, are all the titles necessary to your personal advancement. Only by careful study of these enlightening books, can you gain adequate experience in fields of radio, air conditioning and refrigeration. Each book is uniform. The volumes measure 6 x 9 inches—contain 64 pages, and have stiff, flexible covers. PRICE 50c PER BOOK. All books are sent to you postpaid.

Here Are The Titles:

- | | |
|--|---|
| Book No. 2
MODERN VACUUM TUBES | Book No. 15
ABC OF REFRIGERATION |
| Book No. 3
THE SUPERHETERODYNE BOOK | Book No. 16
PRACTICAL RADIO CIRCUITS |
| Book No. 6
BRINGING ELECTRIC SETS UP-TO-DATE | Book No. 17
SERVICING WITH SET ANALYZERS |
| Book No. 9
AUTOMOBILE RADIO AND SERVICING | Book No. 18
POINT-TO-POINT RESISTANCE ANALYSIS |
| Book No. 10
HOME RECORDING AND ALL ABOUT IT | Book No. 19
PRACTICAL RADIO KINKS AND SHORT CUTS |
| Book No. 12
PUBLIC ADDRESS INSTALLATION AND SERVICE | Book No. 20
THE CATHODE-RAY OSCILLOSCOPE |
| Book No. 13
ABC OF AIR CONDITIONING | Book No. 21
BREAKING INTO RADIO SERVICING |
| Book No. 14
POCKET RADIO GUIDE | Book No. 22
NEW RADIO QUESTIONS AND ANSWERS |

EACH BOOK IN THIS SERIES—50c

RADCRAFT PUBLICATIONS, Inc., 99 HUDSON ST., NEW YORK, N. Y.
Gentlemen: Enclosed find my remittance of \$..... for which send me, POSTPAID, the Manuals or Books indicated below by a cross (x) in the panel.

() Volume 7 @ \$10.00 () 1936 Manual @ \$7.00 () 1935 Manual @ \$7.00
 () 1935 Auto-Manual @ \$2.50 () 1934 Manual @ \$3.50 () 1932 Manual @ \$5.00
 () Refrigeration Manual (Vol. I) @ \$5.00 () Refrigeration Manual (Vol. 2) @ \$5.00
 () Air Conditioning Manual @ \$5.00
RADIO-CRAFT LIBRARY SERIES @ 50c EACH
 Circle book numbers wanted: 2 3 6 9 10 12 13 14 15 16 17 18 19 20 21 22
 Name Address
 City State
 (Send remittance in form of check or money order; register your letter if you send cash or unused U. S. Postage Stamps.) RC-539

Please Say That You Saw It in RADIO-CRAFT

IN REVIEW

RADIOIZED FASHIONS

RADIO-CRAFT last month obtained permission to reproduce Gilbert Rohde's conception, shown on the cover and at right, of how the Man of the 21st Century—will dress.

Vogue magazine invited this industrial designer to apply to the design of clothing the principles he has employed in creating new designs for boilers, clocks, furniture; Mr. Rohde accepted the invitation with the result here shown. Considering only the radio angle of the strange garb, we quote Mr. Rohde: "This new costume, though it involves rational advances, is not entirely a matter of logic and reason. In it, the emotional values have been given new freedom.

"What appears to be a halo on the head is an antenna, which receives and transmits radio waves, and also intercepts a new wave called the Omega. New inventions have made possible both sending and receiving sets of vest-pocket size, although there are no vest-pockets. Feather-weight equipment, carried in the belt, transforms the Omega waves to warm or cool the body through a network of hair-like wires woven into a cloth of synthetic yarn, providing man with an air-conditioned garment."

Other artists, too, accepted the invitation to apply industrial practice to the design of the fashions of the future.

There's George Sakier, for instance; said he, describing one of his original ideas: "All the costumes of the woman of the future will include a wide belt—a hypothetical receptor for high-frequency radiations, emanating from a central source. These are to adapt the body to temperature and altitude changes, by regulating circulation and respiration."

Henry Dreyfuss is quoted as follows regarding a stunning creature in evening dress: "That strange gadget in the lady's hand is (or will be when perfected) a combination electric fan and vanity case. Nothing coquettish about it, for it will get its current by radio waves through the ether and will cool this girl, as well as clip the noses of any unwelcome suitors. The propeller-like blades, made of a transparent plastic, will fold into the interior, which is commodious enough to carry the 8 million contraptions that crowd today's purses."

Joseph B. Platt conceived an electronically-heated coat. We quote: "Fabrics have come to do many things—to shed water, not to crush, to be eternally crisp, or eternally soft; or—as in the case of this coat—a fabric that can be heated at the will of the wearer, like a General Electric blanket. This sports coat is of a soft woolen fibre (a Kinyon
(Continued on page 700)



(Photo—Condé Nast Publications, 1939)

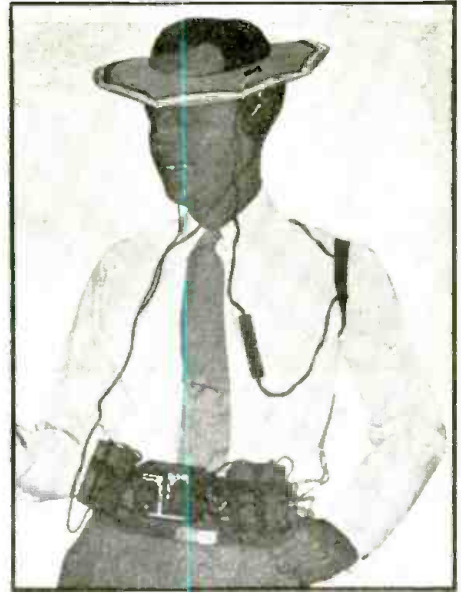

CLOTHES OF YESTERDAY
Above—Reproduction of the cover feature of the Dec. 1937 issue of *Radio-Craft*. The "World's Smallest 3-Tube Radio Set," complete with batteries, is shown on his belt; the "hat" is the loop-antenna.



GOLDEN GATE INTERNATIONAL EXPOSITION
Visitors to the Pacific Coast's Fair will partake in television demonstrations by being televised. The RCA building that houses the television studio and viewing room (insert) provides over 5,000 sq. ft. of space!

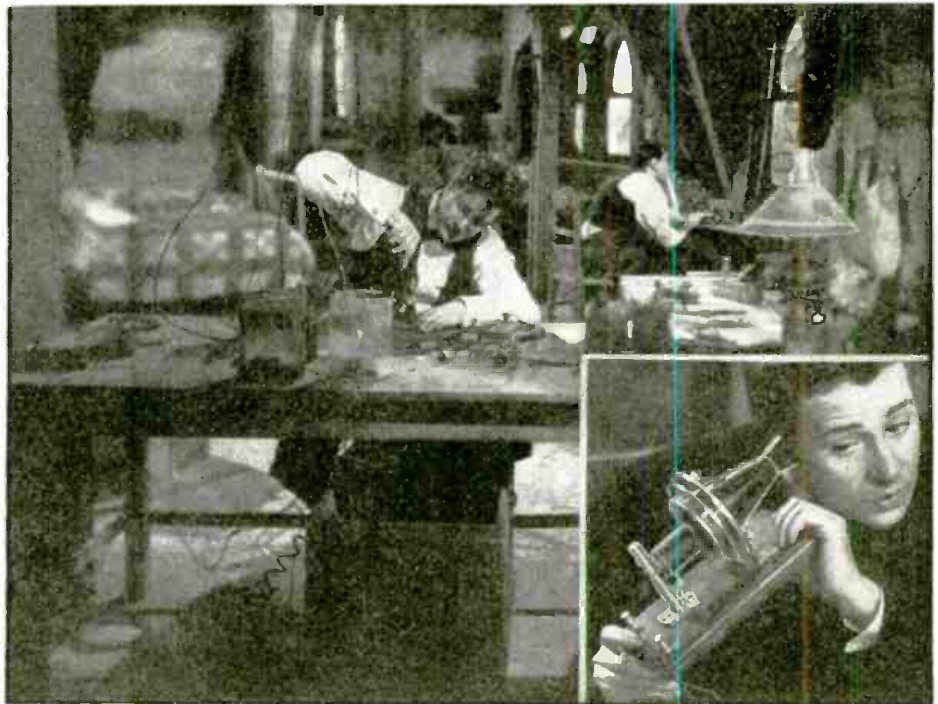

"ALEXANDER GRAHAM BELL"
This new talkie stars Don Ameche as Bell, and Henry Fonda as Watson, both here shown in Bell's 3rd-floor laboratory in Boston, 1876. Inset—Don Ameche (Bell) listens to the progenitor of the hand-telephone, the headphones and the loudspeaker, as well as the magnetic microphone. A 20th Century-Fox.

CARTER MOTOR CO.

CINAUDAGRAPH CORP.

RADOLEK CO.

\$4,000 P.A. CONTEST

\$4,000 Worth of Prizes

(Approximately \$1,000 in prizes per month for 4 consecutive months)
will be given to

**SERVICEMEN, RADIO DEALERS AND
SOUND SPECIALISTS**

for **BEST** letters describing
ACTUAL PUBLIC ADDRESS SYSTEMS INSTALLED

During the Past 8 Months and up to the End of This Contest

OBJECT OF THE CONTEST

PUBLIC ADDRESS is now on the upswing and all indications point to a bigger sound business this coming season. In order to stimulate interest at this time in public address *(Continued on page 701)*

VOCAGRAPH
SOUND
SYSTEMS

EASTERN
MIKE-STAND
CO.

AMPERITE
CO.

ATLAS
SOUND CORP.

UNIVERSITY
LABS.

AMPLIFIER CO.
OF AMERICA

EASTERN
MIKE-STAND
CO.

THE
LIFETIME
CORP.

LAFAYETTE
RADIO CORP.

MONTGOMERY
WARD & CO.

AMPLITONE
PRODUCTS CO.

ALLIED RADIO CORP.

VAC-O-GRIP CO.

LIST OF PRIZES

- FIRST PRIZE—100-W. Complete P.A. System, type 42-75, \$262.55
Offered by Vocagraph Sound Systems
- SECOND PRIZE—18-24 W. Complete Mobile P.A. System, \$149.40
Offered by Lafayette Radio Mfg. Co.
- THIRD PRIZE—25-W. Complete Mobile P.A. System, \$120.00
Offered by Allied Radio Corporation
- FOURTH PRIZE—19-W. Micro-Beam Amplifier, type ACA-19C, \$75.00
Offered by Amplifier Company of America
- FIFTH PRIZE—15-W. Deluxe Amplifier, type AM-15, \$57.00
Offered by Amplitone Products Company
- SIXTH PRIZE—8-W. Complete Portable P.A. System, \$54.20
Offered by Radolek Company
- SEVENTH PRIZE—Velocity Microphone, type RBHK, \$42.00
Offered by Amperite Company
- EIGHTH PRIZE—400-V. High-Power Genemotor, 175 ma. for Portable Amplifier, 6 V. Output, type 415A, \$40.00
Offered by Carter Motor Company
- NINTH PRIZE—4½-Ft. Air Column Trumpet, \$32.50
Offered by University Laboratories
- TENTH PRIZE—Carbon Microphone, type 99, \$30.00
Offered by The Lifetime Corporation
- 2 ELEVENTH PRIZES—Auto-Top Carrier for Mobile Sound Installations, Platform Size, 30 x 54 ins. type PA26, \$22.50
Offered by Vac-O-Grip Company
- Airline Brush Crystal Microphone, \$23.95
Offered by Montgomery, Ward & Company
- 2 TWELFTH PRIZES—12-In. P.M. Speaker, type FB 12-M, \$15.50
Offered by Cinaudagraph Corporation
(Continued on page 702)

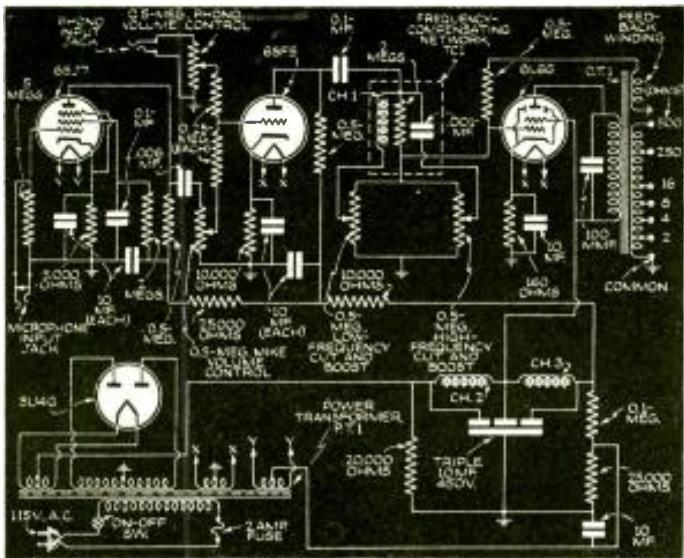

Fig. 1. Complete schematic diagram of the 5-W. high-fidelity versatile amplifier, featuring inverse feedback, and audio frequency spectrum control.

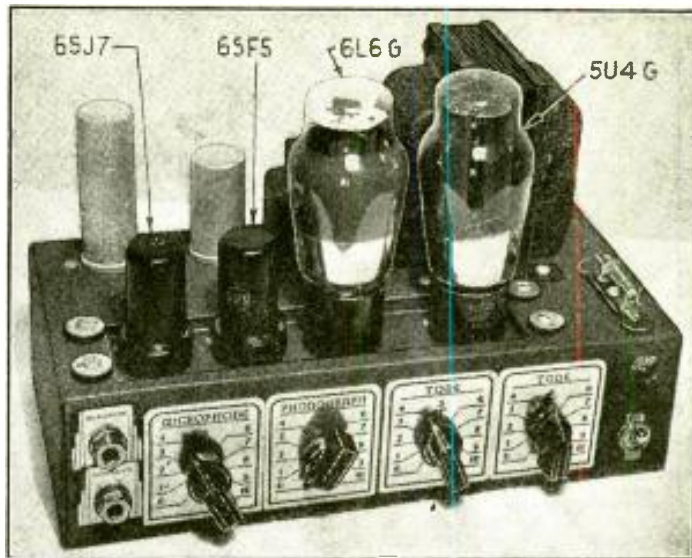

Fig. A. The completed amplifier is a handsome job. The jacks on the left are for microphone and for phono inputs, each with separate control. The tubes are "floated" on a separate, rubber-cushioned plate.

How to Build a High-Fidelity **5-WATT VERSATILE AMPLIFIER**

Latest tube and circuit features are incorporated in this up-to-date, multi-use device. The complete amplifier weighs 15 lbs. (approx.); and measures 11 x 5½ x 7½ ins. high.

H. S. MANNEY

THIS amplifier was primarily designed to fill the need for a good all-purpose low-power unit, which can be easily and economically constructed by any layman, to provide results rarely attained in general type of commercial units. Latest tube and circuit features are incorporated in this up-to-date, multi-use device. The complete amplifier weighs 15 lbs. (approx.); and measures 11 x 5½ x 7½ ins. high.

PERFORMANCE CHARACTERISTICS

As will be noted from a study of the schematic diagram, Fig. 1, the amplifier incorporates such features as individual high- and low-frequency accentuation and attenuation, inverse feedback, and an anti-hum heater circuit for the pre-amplifier tube (6SJ7).

Aside from these unusual and highly valuable features, the amplifier follows a straightforward and economical design. It has a gain of 105 db. at the Microphone Input terminals and 60 db. at the Phono Input terminals. The feedback arrangement which loops the output transformer and output power tube, provides for the production of 5 watts at 2% total harmonics. At lower operating levels, the harmonic content is proportionately less. It will be noted that a universal output transformer is provided so as to readily adapt the amplifier to any output device.

The low-frequency control provides for a 10 db. boost or cut at 50 cycles. The high-frequency control, likewise, provides for a 10 db. boost or cut at 10,000 cycles. This type of frequency

control enables the sound man to compensate for practically any input or output device. For recording, it is highly desirable to attenuate the low-frequency end of the scale so as to obtain a constant amplitude below 250 cycles. During playback, however, it is desirable to boost these frequencies so as to reproduce a well-balanced program. The high-frequency control will normally compensate for any deficiency in microphone or speaker frequency characteristic.

FREQUENCY-COMPENSATING NETWORK

Figure 2 shows the derivation of this unusual type of frequency-compensating network which has already gained popularity in motion picture engineering circles. Figure 2A shows a normal drop in all frequencies encountered by inserting a series resistor between the plate of the 6SF5 and grid of the 6L6G.

Figure 2B shows how the high frequencies are raised by shunting R1 with the 0.001-mf. condenser, so that high-frequency accentuation is produced. This accentuation is, of course, gradual, and increases with frequency, inasmuch as the capacitive reactance of C1 decreases with an increase in frequency. The high-frequency droop characteristic is obtained when the moving arm (Fig. 2C) of the high-frequency control is turned towards ground. This condition only shunts the output of the preceding plate at high frequencies. This action is gradual. That is, greater attenuation is attained at higher frequencies. A normal setting is of course

SOME OF ITS APPLICATIONS

- (1) High-fidelity amplification of radio programs.
- (2) A low-power P.A. system.
- (3) High-fidelity amplification of recorded music.
- (4) All monitoring applications.
- (5) Amplification of electronic instruments.
- (6) Home recording.
- (7) Modulator for amateur radio stations.

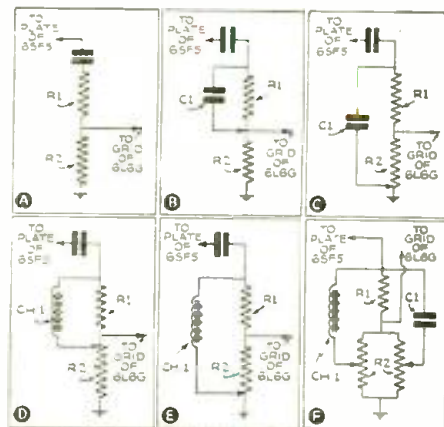

Fig. 2. Sequence of illustrations explaining the derivation of the audio frequency compensating network. See text for details.

obtained midway between the "boost" and "cut" positions.

Similarly, the low frequencies are boosted when a properly-designed choke (Continued on page 688)



STATION KNFG, at Olympia, is headquarters for the state-wide radio network of Washington, the United States' most northwestern state. It is the nerve center of control for the 50 other radio stations of the system.



STATION KACW, mobile unit for rendering medical first-aid, mechanical assistance on the highway, cooperation with the police and fire departments, and other services. It has both receiving and sending equipment.

EMERGENCY NETWORK

Patrols State Highways!

Through the splendid cooperation of the Department of Highways, State of Washington, RADIO-CRAFT has been able to present to its readers the following interesting description of how one state in the Union is operating a radio system that includes snow plows, autos, boats and airplanes in patrol and rescue work.

THE radio network of the State of Washington's Department of Highways is an emergency service and is used primarily for emergency messages and dispatches between fixed stations and mobile stations. These messages may vary from police dispatches to directing the rescue of persons in floods or mountain snow slides.

This department also cooperates with the Department of Fisheries and maintains direct communication with several patrol boats located throughout Puget Sound and the Straits of Juan de Fuca area, doing patrol duty in connection with the enforcement of state fishing

laws on salt water. With the aid of a radio-equipped seaplane these patrol boats are very effective and efficient.

The radio transmitting equipment is under the supervision of the Director of Highways with headquarters at the state capital, Olympia.

At the present time no ultra-high-frequency equipment is used but present work and development on those frequencies are being watched with interest and when practical necessity demands, such equipment will be incorporated in this system. Due to the long distances and the mountainous sections to be covered, we cannot efficiently use those frequencies at the present time.

RADIO SNOW PLOWS

One of the most important phases of our communication is keeping constant contact with mobile equipment in remote locations, especially during the winter months. At the present time (January, 1939) there are 20 mobile units in operation with construction going ahead on others. These units are 2-way equipment working entirely on 2,490 kilocycles and using voice. Of these, 12 are large rotary snow plows stationed in the mountain passes and operating over highways that have heavy snowfall.

Constant 2-way communication is maintained between these mobile units

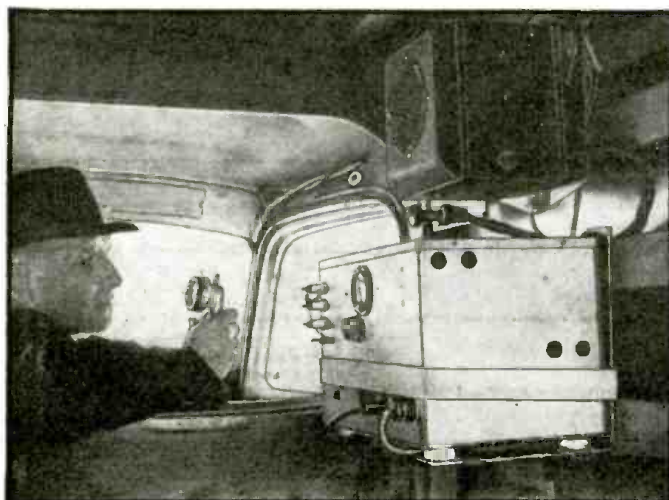

STATION KOCZ, 30-W. mobile unit patrolling Snoqualmie Summit. The equipment is mounted in the truck, convenient to the driver who is in almost constant communication with headquarters at Olympia.



STATION KGHC is a 10-W. mobile unit located in the cab of a rotary snow-plow operating in the Snoqualmie Summit area. A battery-operated 12-V. dynamotor supplies the transmitter's power. The receiver is a police-type superhet.

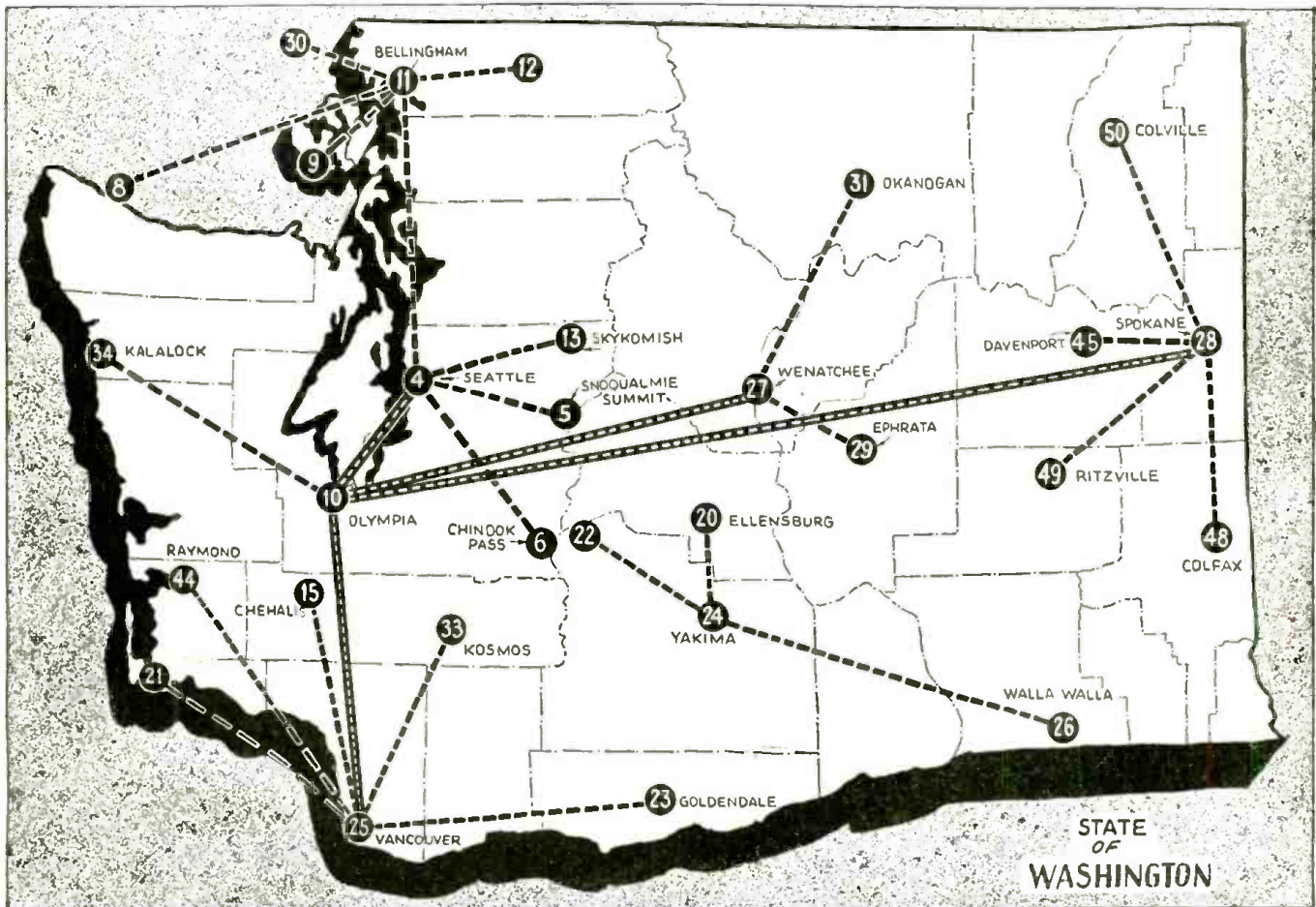

Map of the entire State of Washington, showing the complete network of 51 stations which constitute one of the most complete radio services in the country. The radio system is an emergency service primarily for messages and dispatches between fixed and mobile stations. The State departments connected with this service include police, fire, fisheries, highways, etc. One of the stations is located in a seaplane used in connection with fisheries control.

and the higher powered fixed stations located at widely scattered locations throughout the state. By means of these mobile units, immediate information can be obtained by the district headquarters office of snow and highway conditions on important highways. If information is received that any section of highway is being blocked with heavy snow or slides, one or more of these fast-moving rotary plows can be dispatched to that section and report progress or request repair parts in case of a breakdown. Several instances have occurred on mountain passes of snow slides blocking the roads temporarily and these plows have proceeded to the location, clearing the road rapidly and notifying stations on each side of the obstruction, which had in the meantime stopped traffic to reduce congestion and danger to the public, that traffic could proceed. *Radio has aided materially in the rescue of persons caught in slides or in dangerous positions in snowslide areas.*

OTHER MOBILE UNITS

Five state cars equipped with 2-way equipment materially aid in supplying communication with points endangered by floods, slides, strikes or catastrophes where the public is affected. Two state planes, also so equipped, furnish communication when called into service for emergencies or investigations. Twenty-four fixed stations, up to 250 watts output, are operated throughout the state

to furnish contact with mobile units or between fixed stations at remote points. The larger of these stations use 5 frequencies with both voice and code transmission as well as several receivers standing by on all frequencies employed.

Most of the equipment used for radio communication is factory-built with some exceptions of model or small equipment which is built in our own shops. The mobile receivers are all of a well-known police receiver make and are set and locked on 2,490 kilocycles. The circuit is superheterodyne and the oscillator tube crystal-controlled to insure stability. The mobile transmitters vary in power from 10 to 50 watts output, 100% modulated, and are powered from a 12-volt dynamotor operated by the standard 12-volt battery or two 6-volt batteries connected for series-parallel operation. They are factory-built to our specifications and represent a compact and dependable unit, designed to withstand moisture and vibration which are present when used in such equipment. Several types of antenna are used for mobile service, namely, vertical telescoping rods, and 1-inch pipe mounted on top of the snow plow in the form of a vertical loop with the chassis forming the return. These loops are approximately 3 feet high and 13 feet long, being tuned to resonance by a predetermined fixed capacity and feed by a single-wire transmission line. (Continued on page 696)



STATION KGHB—in action. One of the giant rotary plows used to keep the highways of the State of Washington open during winter months.

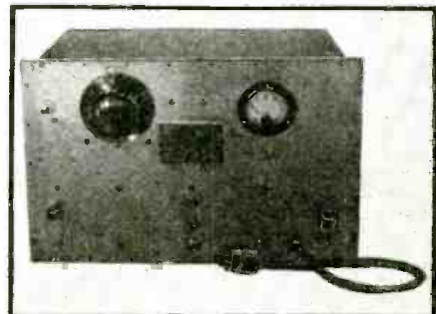

A typical 50-W. mobile transmitter. These relatively high-powered units are used in the more outlying stations of the network.

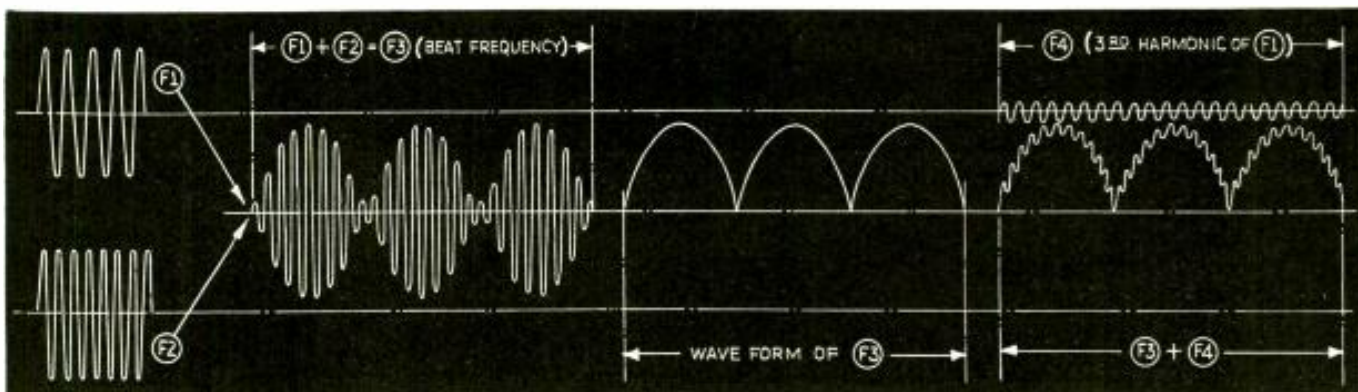

Intermodulation Distortion is not the same thing as Harmonic Distortion but instead is much more involved as the above illustration shows. Intermodulation distortion becomes more apparent in the output (that is as heard from the loudspeaker) as the effect adds up because of numerous intermodulations—mixing of one frequency with another—taking place simultaneously. Basically, however, the action is that of the single intermodulation here shown as an example. Frequencies F_1 and F_2 combine to form a beat-frequency F_3 . (Cancellation produces zero beats.) The envelope of F_3 then may become modulated by the 3rd harmonic, F_4 , of one of the fundamental frequencies (in above example, F_1).

INTERMODULATION—*And its*

An enlightening discussion which solves the enigma of distortion and focuses reproduction. For simplicity of presentation, the author has intentionally avoided

WHAT is distortion? What is the difference between *subjective* and *objective* distortion? Can distortion improve quality? Can the ear differentiate between discords and distortion? Is quality improved or impaired by intermodulation? How is it produced?

DEFINITIONS

There are 4 types of distortion:

(1) *Frequency Distortion* is produced when a non-linear condition exists between gain and frequency (the gain of the amplifier changes with frequency).

(2) *Phase Distortion* is produced when a non-linear condition exists between phase shift and frequency (some frequencies of a complex wave are passed through a circuit faster than its associated components—and arrive at the end of the circuit either ahead or behind its associated frequencies thereby changing the overall waveform).

(3) *Amplitude Distortion* is produced when a non-linear condition exists between input and output amplitudes (changes of input amplitude do not produce a corresponding change in output. This condition produces extraneous harmonics).

(4) *Directional Distortion* is produced when a non-linear condition exists between the original sound source and the reproduced version (the sound does not seem to come from the orator—usually caused by improper placement of speakers—may be eliminated by amplification in auditory perspective).

A complete discussion covering the complexity of distortion and its relation to the products of intermodulation *could easily fill a volume!* For purposes of brevity it is therefore necessary to

Simple Harmonic Distortion—

—is a factor, in the design and operation of high-quality amplifier systems, with which almost every designer and user of a P. A. system is familiar. However public-address specialists usually fail to differentiate or even to recognize when distortion in the output of a sound system is due to intermodulation; and its effect upon the quality of reproduction is practically ignored in modern distortion measurements! Since the importance of Intermodulation Distortion only recently has been recognized by foremost sound technicians there is almost no published information available on the subject. Radio-Craft feels therefore that this article by Mr. Shaney is an outstanding contribution to sound literature.

limit our discussion to intermodulation and its relation to *amplitude* distortion instead of the encompassing title heading this article.

WHAT IS DISTORTION?

Before delving into the processes of intermodulation, let us briefly review the essentials of quality and their relation to distortion. What is distortion? Seventeen years of close association with circuits and components involving the reproduction of sound have brought the writer in contact with two schools of thought in relation to distortion and quality.

One group—composed mainly of musicians and non-technical experts, ask, "Does it sound like the real thing?" This group, unknowingly, objects to "subjective distortion," a mental interpretation of quality based upon indi-

vidual reaction to aural response usually conditioned by previous training, experience, or lack of one or both. Their final test for perfection is made by actual listening test. Their reaction may be obtained by simply asking, "How does it sound?"

These "subjective distortionists" use their ears for the final analysis, and by its reaction condone or condemn quality of reproduction. On the other hand, we have a group composed mainly of engineers and laboratory technicians who ask, "What is its harmonic content at various output levels?" This group knowingly objects to "objective distortion"—a physical interpretation of quality based upon laboratory measurements conditioned by the state of the art. Their final test for perfection is made with measuring instruments. Results of their amplitude distortion tests are found in the answer to, "What is its total harmonic content at — watts?" Most "objective distortionists" will condemn or condone a reproducing system based on waveform analysis and meter readings — without listening at all!

WHAT IS INTERMODULATION?

Regardless of whether subjective or objective methods of judging quality are used, careful consideration must be given to intermodulation if any degree of accuracy is to be attained in gauging quality.

For our purposes, *intermodulation* may be defined as the interference patterns caused by interaction of two or more signals in one channel. See Fig. 1. Intermodulation is commonly encountered in the production of beat notes when two or more frequencies combine to produce image frequencies. (Two extraneous frequencies equal to the sum and differences of the original frequencies.)

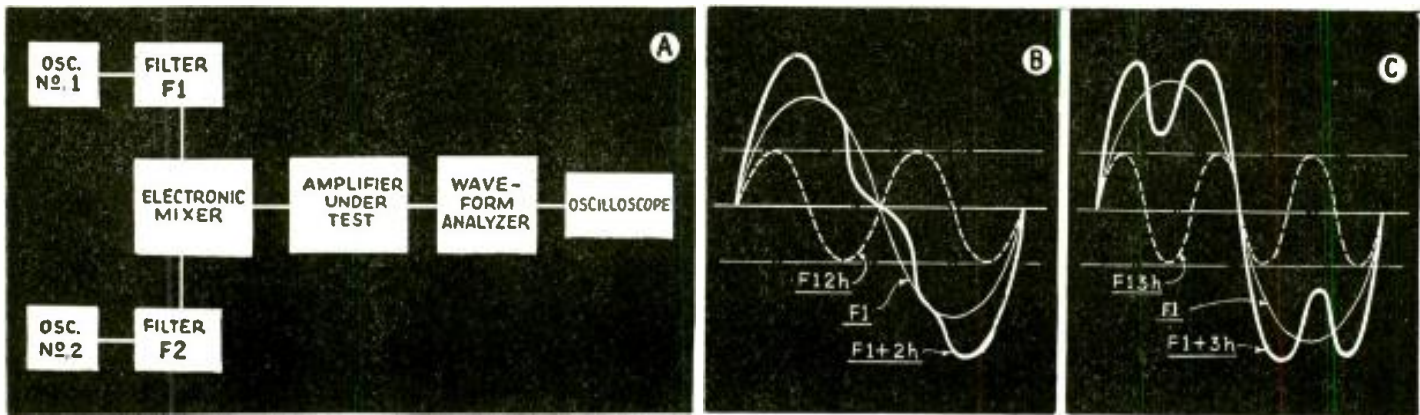

A—Equipment used for studying the products of intermodulation. Oscillators Nos. 1 and 2 produce frequencies which for the purpose of intermodulation analysis must be further filtered so that only individual frequencies reach the electronic mixer.
 B—Intermodulation is the interference pattern caused by interaction of 2 or more signals in one channel. Ordinary harmonic distortion is shown at B.
 C—When strong odd harmonics are present intermodulation distortion becomes a serious factor at the output of an amplifying system.

Relation to Distortion

A. C. SHANEY

attention upon an important factor heretofore overlooked in measuring high-fidelity mathematical treatment and has limited his discussion to the audio frequencies.

INTERMODULATION: HOW AND WHERE IT IS PRODUCED

Intermodulatory frequencies may be produced within any transmitting channel or transducing component. They most commonly occur in air when two sound waves (of slightly different frequency) unite with each other. If the waves are of equal amplitude, complete cancellation will take place during opposite phase relationship to produce beats. These beats represent the difference of the frequencies. Similar beats will be produced in the ear (and brain) when different frequencies of equal amplitude are fed to each ear (provided the auditory responses of both ears are alike).

This same set of acoustical and physiological conditions may be duplicated in an electrical circuit, microphone, speaker, transformer, tube, etc.

The process of intermodulation, however, does not stop with the mere production of beat notes. It continues on to react with all extraneous frequencies introduced into a non-linear system until it ultimately alters the character of the original frequency to a considerable degree.

PRODUCTS OF INTERMODULATION

Let us assume for a moment that a typical single-ended amplifier has a given amount (say 5% total) of 2nd, 3rd, 4th, 5th, and 7th harmonics at some specified output line. If a 2,000-cycle signal is fed into the amplifier we would expect to find the following frequencies at the output:

- Fundamental 2,000 cycles (F1)
- 2nd Harmonic . . . 4,000 cycles (F1h2)
- 3rd Harmonic . . . 6,000 cycles (F1h3)
- 4th Harmonic . . . 8,000 cycles (F1h4)
- 5th Harmonic . . . 10,000 cycles (F1h5)
- 7th Harmonic . . . 14,000 cycles (F1h7)

If in addition to the 2,000-cycle signal, a signal of 800 cycles is also fed

into the amplifier, we would expect to find the following additional frequencies at the output:

- Fundamental 800 (F2)
- 2nd Harmonic 1,600 (F2h2)
- 3rd Harmonic 2,400 (F2h3)
- 4th Harmonic 3,200 (F2h4)
- 5th Harmonic 4,000 (F2h5)
- 7th Harmonic 5,600 (F2h7)

If a careful analysis of the output waveform is made, the following additional frequencies will also be detected:

			4,800	7,200	10,800
400	2,600	5,200	7,600		
1,200	2,800	5,600	8,400		
1,600	3,200	6,400	8,800		
2,200	3,600	6,800	9,200		
2,400	4,400				

If the total harmonic content is now measured (products of intermodulation are not all harmonics but will be measured and considered as such insofar as their relation upon distortion is concerned) it will be found that instead of the original 5% total this amount will have nearly tripled to 14%!

All of these extraneous frequencies are merely the intermodulation products (sums and differences) of both fundamental frequencies interacting between themselves and their associated harmonics. Table I further clarifies the production of these extraneous frequencies:

TABLE I			
Intermodulation Factors		Resultant Frequencies	
F1 + F2	2,000 + 800	=	2,800
F1 - F2	2,000 - 800	=	1,200
F1h2 + F2	4,000 + 800	=	4,800
F1h2 - F2	4,000 - 800	=	3,200
F1 + F2h2	2,000 + 1,600	=	3,600
F1 - F2h2	2,000 - 1,600	=	400
F2h2 + F1h2	4,000 + 1,600	=	5,600
F2h2 - F1h2	4,000 - 1,600	=	2,400

Intermodulation Factors

Intermodulation Factors		Resultant Frequencies	
F1h3 + F2	6,000 + 800	=	6,800
F1h3 - F2	6,000 - 800	=	5,200
F2h3 + F1	2,400 + 200	=	2,600
F2h3 - F1	2,500 - 200	=	2,200
F1h3 + F2h2	6,000 + 1,600	=	7,600
F1h3 - F2h2	6,000 - 1,600	=	4,400
F1h2 + F2h3	4,000 + 2,400	=	6,400
F1h2 - F2h3	4,000 - 2,400	=	1,600
F1h4 + F2	8,000 + 800	=	8,800
F1h4 - F2	8,000 - 800	=	7,200
F2h4 + F1	3,200 + 2,000	=	3,400
F2h4 - F1	3,200 - 2,000	=	1,200
F1h5 + F2	10,000 + 800	=	10,800
F1h5 - F2	10,000 - 800	=	9,200
F2h5 + F1	4,000 + 2,000	=	6,000
F2h5 - F1	4,000 - 2,000	=	2,000
F1h4 + F2h2	8,000 + 1,600	=	9,600
F1h4 - F2h2	8,000 - 1,600	=	6,400
F1h2 + F2h4	4,000 + 3,200	=	7,200
F1h2 - F2h4	4,000 - 3,200	=	800
F1h3 + F2h3	6,000 + 2,400	=	8,400
F1h3 - F2h3	6,000 - 2,400	=	3,600

INTERMODULATORY RELATIONSHIPS

From both the objective and subjective viewpoints, it is of prime importance to realize that products of intermodulation are far more disturbing than simple harmonics.

It is well known that when two tones bearing some simple integral relation to each other, are sounded together, they form the most harmonious combination which it is possible to obtain. These characteristics of tones were recognized in the earliest times, long before anything whatever was known about harmonics. In fact the quality of a tone is determined by the intensity and number of low-order harmonics

(Continued on page 689)

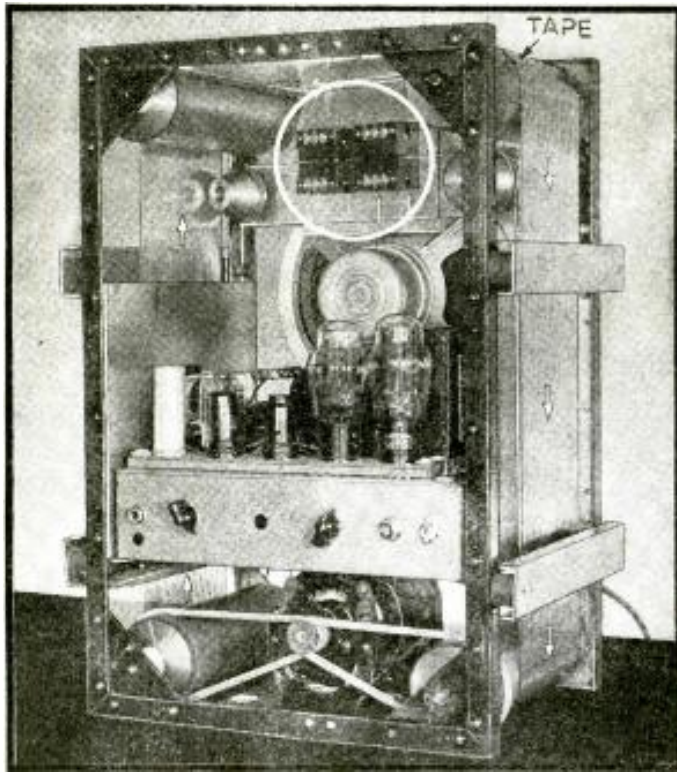

Complete Soundmiror (illustrated on cover) with cabinet removed. The steel wire tape is a 35-turn coil that revolves on 4 cylinder bearings; recordings on this tape automatically repeat every few minutes. The recording-and-playback, and erasing heads are encircled.

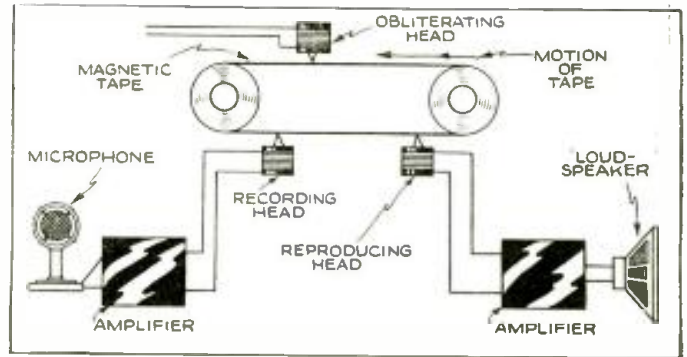

Theoretical diagram of the Soundmiror. Although separate recording and playback are shown here, in actual practice one head automatically serves these dual functions.

SOUND-

A specific model of sound recording production. It operates by magnetizing the electrical currents produced during recording. Reproduction is then accomplished by trans-reproducing by loudspeaker into

• COVER FEATURE •

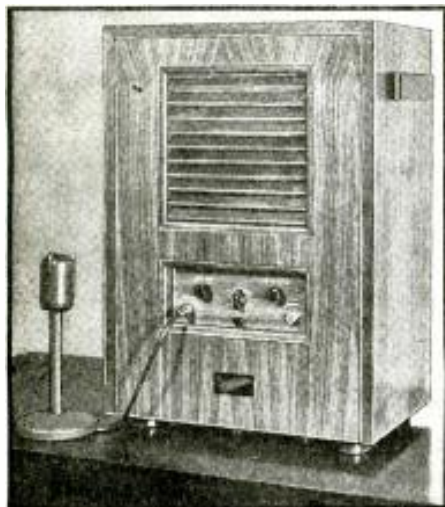

Complete Soundmiror with microphone; size, 25x17x12 ins. deep. Control panel consists of volume control, amplifier motor switch, timing dial and 2 connecting plugs, one for mike and the other for recording and reproducing phonograph records.

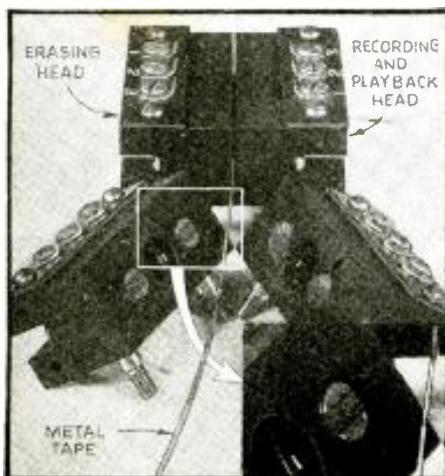

"Heads". Closed—erasing head; open—recording-playback head. Inset is a close-up of the pole pieces.

THIRTY-NINE years ago Prof. Vladimir Poulson demonstrated a method (1) for recording sound on a moving iron wire and of reproducing that sound, at leisure and without processing, as many times as desired; and of erasing the sound and re-recording new sounds on the same wire. Last month a well-known engineering group culminated years of intensive research by announcing the availability of a "Soundmiror" that demonstrates the commercial practicability of Poulson's principle of magnetic recording and playback of sound.

During the interim, *sound-on-film* and *sound-on-disc* had its innings, and many laboratory experiments in recording and reproducing sound were undertaken; an interesting, recent experiment being the use of a static charge on moving paper tape (2). Underlying all the progress in these directions, however, was the fact that "magnetic phonography" possessed inherent advantages over all other methods. For this reason many independent researches were made toward overcoming the faults in technique that, since the fold-up of Prof. Poulson's venture into the commercial field with his "Telegraphone," had delayed the commercialization of *sound-on-wire* (or tape).

DEVELOPMENT

Bell Laboratories (3), for instance, is one group that found ways and means of utilizing technical advances and inventions—in (mainly) magnetic materials, amplifier designs, frequency fil-

ters—to overcome what were otherwise insurmountable obstacles in the methods and apparatus originally employed by Prof. Poulson. The New Jersey Bell System has found magnetic recording-playback a practical means of giving up-to-the-minute announcements of potato prices, and car movements and loadings, over the local telephone system in the farming district of Hightstown, N. J. Other applications are being developed.

Coincident progress has been made in Europe. The British Broadcasting Corp. is now regularly using a highly-perfected type of magnetic recorder and playback (in lieu of the sound-on-disc ["transcription"] method universally employed in America as program fill-ins) known as the Marconi-Stille Recorder and Reproducer (4, 5); this device, with a frequency-reproducing range out to about 8,000 cycles (with no background noise), shows the advance that has been possible mainly through the use of the tube-type amplifier and, last but not least, *steel tape*. In Germany, the "R.R.G. of Berlin" recently introduced the Magnetophone (a non-inflammable film, 6.5 mm. wide, "coated with a thin layer of powdered metal") (6) for portable recording, due to it being completely unaffected by jolts in moving vehicles!

COMMERCIALIZATION

First sign of American supremacy in this field, insofar as it concerned Mr. John Q. Public, came in the Spring of 1937 with the announcement by Dr.

(1) "Sound Recording on Magnetic Materials." Radio-Craft, Mar., 1936.
 (2) "On the Electrographic Recording of Fast Electrical Phenomena." Journal of Applied Physics, Oct., 1938.
 (3) "Magnetic Recording and Reproducing." Bell Laboratories Record, Sept., 1937.

(4) "Storing Speech and Music." Newnes Practical Mechanics, Apr., 1938.
 (5) "The Steel Tape Recorder." Practical and Amateur Wireless, July 2, 1938.
 (6) "Recording for Re-Broadcasting in Germany." Wireless World, Mar. 31, 1938.

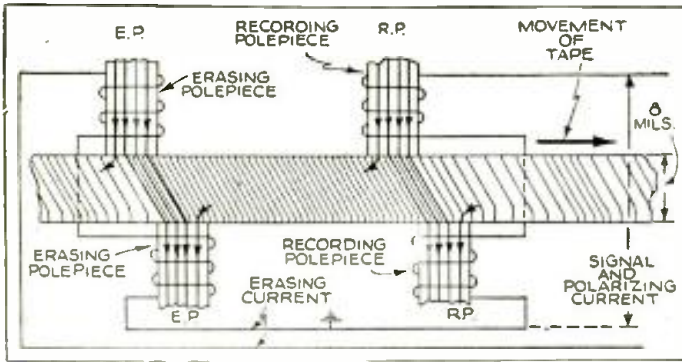

Schematic detail of erasing and recording actions. Maximum magnetic influence is obtained by virtue of the pole pieces touching the moving tape; by applying D.C. to polarize the winding and then modulating this D.C. with the signal, and by magnetizing the longest path through the tape.

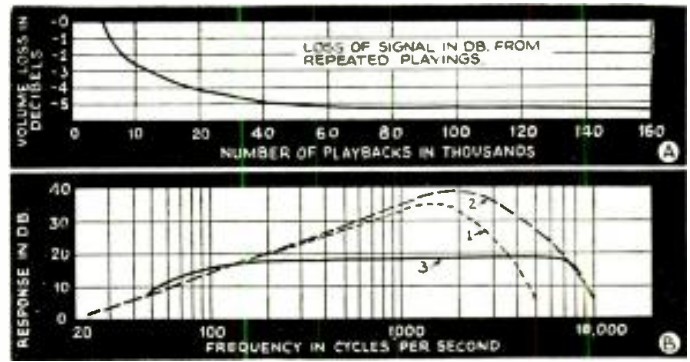

Graph A illustrates the loss of signal in db. from repeated playings of magnetic sound record on tungsten steel, 120 x 8 mils thick. Graph B shows frequency response of Soundmiror; an attenuation network makes curve 3 possible.

ON-WIRE TAPE!

and reproducing machine, the Soundmiror, is now in ing a sound pattern on a steel tape in accordance with by sound vibrations entering a microphone. Repro- ferring the magnetic pattern into electric currents and sound. Many valuable results are obtained.

APPLICATIONS OF THE SOUNDMIROR

Primarily, for use in the educational fields, for colleges, high schools, and grade schools in their language departments, debating, elocution, drama and music groups, and for elementary vocabulary and pronunciation teaching.

In the entertainment field, by radio stations for auditions, transcriptions, background effects, and practice work (and in checking program delivery, timing, etc.).

These applications can also be made in theatres, movie studios, and auditoriums.

Entertainment personalities will find this method of sound recording and reproducing a great advance in training methods.

In the commercial field, it may be used as an announcement and call system, repeating the message over and over as many times as desired.

In stores, a master unit may be set up to deliver sales messages to loudspeakers in many departments. Individual units at counters may be used to call attention to items being featured, and their merits.

The microphone, amplifier and loud-speaker may be used separately as a 12-watt public address and call system.

Pickup heads spotted at 5 or 6 points on the steel-tape helix may be used to introduce a time factor in the reproduction; thus an *echo effect* of any desired length of echo may be synthesized for use in broadcast station programs.

Alarm systems in banks, lofts, etc., may be arranged to start the Soundmiror operating to repeat a previously-recorded message, calling attention to the alarm and sending location information, etc., over wires to police headquarters or/and over short waves to be picked up by radio police cars.

Placed at street intersections, these Soundmirors, in modified form, may soon (Continued on page 685)

R. D. WASHBURNE

Director of Physics, Applied Physics, and of Research Laboratory and Experimental Physics, Mass. Inst. of Technology.

Q. & A.

Questions and answers regarding the Soundmiror quickly disclose the construction, sales and service aspects and possibilities of this new development in sound-on-steel-tape.

1—How expensive is the soundmiror? Actual dollars-and-cents figures cannot be given here but it is evident by inspection that due to the absence of an exciter lamp, photocell and the attendant, necessarily precise construction, it is far less costly to produce than sound-on-film equipment. And, since there is no additional cost for recording discs, no breakage, no wearing out of the recording due to needle pressure and deformation, and the more rugged principle of operation, it is on these (Continued on page 684)

Begun and S. K. Wolf of a "30-sec. unit for use by teachers and students in voice culture (7); the frequency range was 100 to 8,000 cycles. Second sign came last year, in an article by Dr. Begun (8), with the introduction of a larger machine capable of operating "from 15 seconds to several minutes"; (readers interested in this subject will find it worthwhile to look up one of the references [9] mentioned here.

A perfected form of Dr. Begun's magnetic recorder-reproducer just announced is the "2 to 10 minute" Soundmiror shown here and on the cover of this issue of *Radio-Craft*. Details of this machine made available by Acoustic Consultants, Inc., include excerpts (some of which we reproduce below) of a Report by Prof. George R. Harrison,

(7) "Magnetic Recording-Reproducing Machine for Objective Speech Study," *Journal of the S.M.P.E.*, Vol. XXIX, No. 2, 1937.

(8) "Magnetic Recording," *Electronics*, Sept., 1938.

(9) "Some Aspects of Magnetic Recording and Its Application to Broadcasting," *Proc. I.E.E.* (London), Mar., 1938.

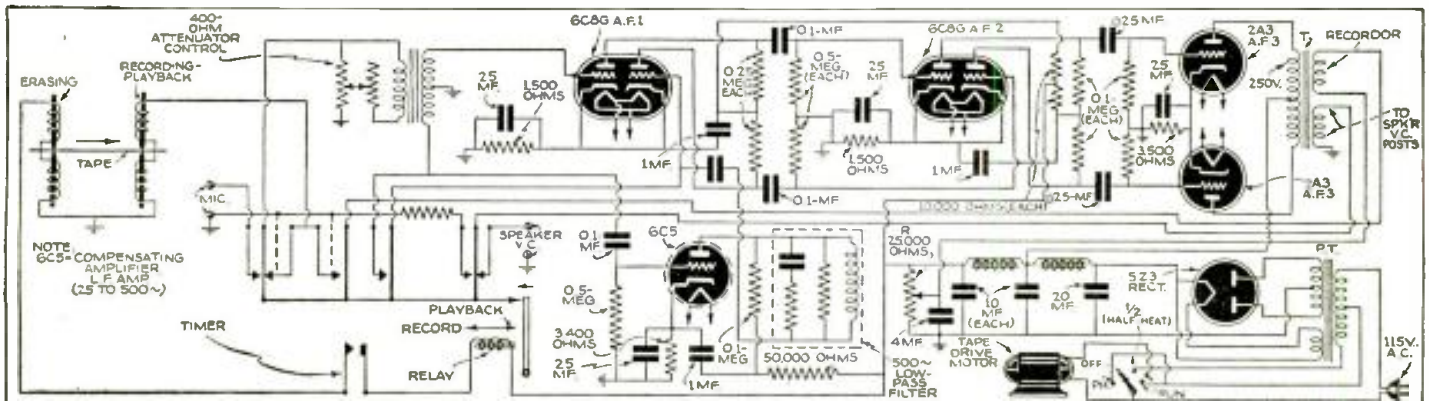

Schematic circuit of the Soundmiror. This diagram has been engineered to meet the unusual requirements in making recordings on steel tape over a frequency range equalling or exceeding that encountered in high-fidelity broadcasting.

48 NEW TUBES

New tubes this month include types incorporating very important advances in tube technique for application in many fields. Outstanding are many for use in television transmission, reception and testing. Other types are of interest in the general operation of radio transmitters and receivers. The mushroom growth of portable and ultra-shortwave equipment receives continued impetus from new tubes.

R. D. WASHBURNE

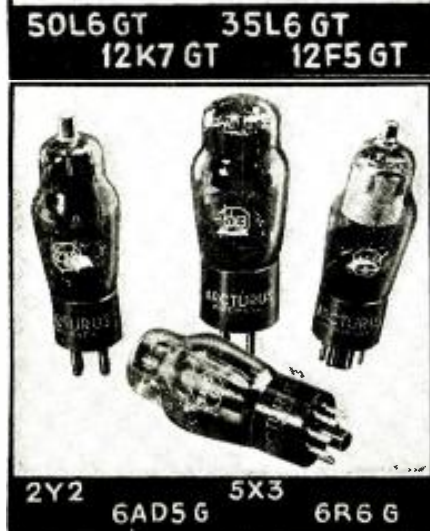

RADIO-CRAFT at frequent intervals has printed grouped descriptions of new tubes. This month's article however smashes precedent in two directions. First, an even 4-dozen new tubes bring life-blood to equipment for many more services—and headaches to memory experts trying to keep tabs on the new tube-type numbers. Second, the number of tube types written-up sets a new high.

All available basic characteristic data are given; in a few instances, though, the tubes are so new only the barest mention of the tubes and the services they perform have been permitted by the manufacturer. The tubes have been described, just as released by the respective manufacturers, in coordinated groups; and in the approximate sequence with which they are pictured on these pages. All available symbols, in numerical sequence for quick reference, are shown. (Note that in one or two instances certain less recent tubes have been included here in order to keep the records of *Radio-Craft* readers as complete as possible.)

First of the tubes to be considered this month are types employing the "loctal" or lock-pin base first introduced in connection with the type 1231 television tube. (See *Radio-Craft*, November 1938.) The new group however is particularly applicable in the general broadcast and P.A. field; in fact, sets using these tubes are being marketed.

LOCTAL TUBES

The following group of 8 loctal tubes was introduced last month by Hygrade Sylvania Corporation.

The loctal type of construction provides compactness, suitable shielding, and a lock-in feature; as well as the "single-ended" feature which eliminates the top cap connection.

Because of the difference of construction these new tubes obviously are not intended as, nor can they be used as, replacement tubes for any other types having different type numbers.

The "loctal" type of construction employed in these new tubes is the same as that of the Sylvania 1231. It consists of an all-glass-envelope tube without the familiar bakelite base. The contact pins are sealed into the glass bottom, thus eliminating soldered connections. The lower portion of the tube is fitted with a metal shell and guide pin. This unit acts as a shield and makes possible the lock-in feature by employing a groove around the bottom of the locating pin which fits into a catch on the socket.

7A6—Duodiode

This loctal-base tube has separate cathodes and is quite similar to the 6H6G (1) except that heater current is only 150 ma.

(1) For A.C. service the 7-V. heater rating corresponds to a 130-V. line condition. It is also the nominal voltage for automotive receiver service.

and may be operated in either series or parallel circuits.

Tentative characteristics—Table I.

7A7—Triple-Grid Variable-Mu Amplifier

This R.F. and I.F. amplifier is quite similar to the type 6K7G. The mutual conductance of the type 7A7 is higher. (1)

Tentative characteristics—Table II.

7A8—Octal Converter

This tube has characteristics quite similar to the types 6A7 and 6A8G. (1)

Tentative characteristics—Table III.

7C6—Duodiode High-Mu Triode

The characteristics except for heater ratings are quite similar to the type 75. The triode section should not be employed with fixed-bias. A high value of grid resistor is required and the triode operated essentially under zero bias conditions. With a plate supply voltage of 250 V. the plate load resistor should be approximately 0.25-meg. For special applications this value may be varied to suit the conditions. Conventional circuits are applicable for the diodes. (1)

Tentative characteristics—Table IV.

7B7—Triple-Grid Variable-Mu Amplifier

The characteristics of this tube are like those for the type 6S7G; applications are similar to those for the 6S7G and 6K7G. (1)

Tentative characteristics—Table V.

7Y4—Full-Wave High-Vacuum Rectifier

In characteristics and applications this tube is similar to the type 84. (1)

Tentative characteristics—Table VI.

35A5—Power Amplifier Pentode

This tube is somewhat similar to the type 25L6G and is intended especially for use in the output stage of A.C.-D.C. and D.C. receivers. Heater is of 150-ma. type and designed for series operation. If fixed-bias is employed the grid circuit resistance should not exceed 0.1-meg. The maximum resistance with self-bias is 0.5-meg.

Tentative characteristics—Table VII.

35Z3—High-Vacuum Half-Wave Rectifier

This tube is designed for use in receivers where the type 35A5 is employed as the output tube. Same heater rating for both tubes permits series operation. Input voltages in excess of 125 V. A.C. require the use of a 100-ohm resistor in series with the plate.

Tentative characteristics—Table VIII.

A series of 12 loctal tubes was introduced by Raytheon Production Corp., last month. Of this group, 4 types (7B5, 7B6, 7B8 and 7C5) not previously discussed, are described below.

7B5—Pentode Power Amplifier

This heater-type tube is designed for service in the output stage of storage bat-



tery or A.C.-operated receivers. Its characteristics are the same as the type 41.

Transformer- or impedance-input coupling devices are recommended. If resistance coupling is used, the D.C. resistance in the grid circuit should not exceed 1 meg. with self-bias, or 0.1-meg. with fixed-bias.

Characteristics—Table IX.

7B6—Duodiode-Triode Detector-Amplifier

This tube is similar to the type 75. It is designed for use as a combined diode detector, A.V.C. rectifier and resistance-capacity coupled A.F. amplifier in radio receivers.

The 2 diodes are independent of each other and of the triode section except for the common cathodes. The diodes may be used as a half-wave or a full-wave rectifier; or one diode may be used as a half-wave rectifier for detection and the other diode used as a rectifier to obtain delayed A.V.C. voltage.

Characteristics—Table X.

7B8—Heptode Pentagrid Converter

Similar in characteristics to type 6A7. This pentagrid-type converter is designed for use as a combined oscillator and mixer in superheterodyne receivers.

Characteristics—Table XI.

7C5—Tetrode Power Amplifier

Similar to 6V6. For use in the output stage of radio receivers.

Characteristics—Table XII.

NEW MIDGET "COOL" TUBES

A group of 9 midget tubes designed for series heater operation in A.C.-D.C. receivers which make possible the elimination of plug-in resistors was introduced by Arcturus Radio Tube Company last month. This construction, which permits a 50% reduction in the operating temperature of the receiver, obviates the need for line cord resistances, "immediately qualifying the receiver for Underwriters Laboratories' approval."

The new tubes, all of them already in production, require only half the heater current as compared to previous designs using 0.3-A. A small, separate wire-wound resistance connected in series with the tubes and placed inside the set chassis, re-

places the plug-in resistors (ballast tubes) or line cord resistances.

The design of this new series is such that filament power is used efficiently and economically in the cathodes of the tubes themselves, rather than being dissipated uselessly to a large extent by ballast tubes or other types of resistance units in the form of heat. As a result, the entire radio receiver operates cooler. There is far less damage to other components such as resistors, cabinets and condensers by excess heat.

The heater current on all 9 of the tubes is only 150 milliamperes to meet the present-day demand for less current consumption. The new tubes afford a choice of either 35- or 50-V. output tubes; a 25-V. doubling rectifier or a 35-V. half-wave rectifier, thus permitting a wide range of design ingenuity.

12A8GT—Pentagrid Converter

Characteristics—Table XIII.

12F5GT—High-Mu Triode

Characteristics—Table XIV.

12J7GT—Pentode Detector Amplifier

Characteristics—Table XV.

12K7GT—Remote Cut-Off Pentode Amplifier

Characteristics—Table XVI.

12Q7GT—Duplex Diode High-Mu Triode

Characteristics—Table XVII.

35L6GT—Beam Power Amplifier

Characteristics—Table XVIII.

35Z4GT—Half-Wave High Vacuum Rectifier

Characteristics—Table XIX.

50L6GT—Beam Power Output Tube

Characteristics—Not yet released.

25X6GT—Multi-Purpose Rectifier

Characteristics—Not yet released.

NEW TELEVISION AND OSCILLOSCOPE TUBES

Several new tube types for rectifying, amplifying and oscillator applications in

television and cathode-ray tube apparatus have been announced by the Arcturus Radio Tube Company.

Warning—As with all cathode-ray tubes, but particularly the types designed for television, it should always be remembered that high voltages may appear at normally low-potential points in the circuit, due to condenser breakdown or to incorrect circuit connections. Therefore, before any part of a C.-R. tube circuit is touched, the power-supply switch should be turned off and both terminals of any charged condenser grounded.

2Y2—Half-Wave High-Vacuum Rectifier

This tube is designed for use in cathode-ray oscilloscopes and television circuits where high voltage and low current are required. It is a slow-heating type and is used with quick-heating tubes in the sweep circuits, thus avoiding burning the cathode-ray tube viewing screen at one spot before the sweep oscillators start to function. It is essential that tubes used in the sweep circuits be quick heaters such as types 6X3, 6R6G and 6AD5G.

Characteristics—Table XX.

5X3—Full-Wave High-Vacuum Filament-Type Rectifier

This tube is suitable for use where fairly high voltage and low current are required in cathode-ray oscilloscope and television circuits.

Characteristics—Table XXI.

6AD5G—High-Vacuum Sweep Oscillator or Amplifier

This tube is suitable for use in cathode-ray amplifier or television circuits where the call is for high plate voltage with low plate current to drive deflection plates of cathode-ray tubes. This unit is especially insulated to withstand high surge voltages, but the plate dissipation must be limited by a series protective resistor.

Characteristics—Table XXII.

6R6G—Remote Cut-Off Pentode Amplifier

The characteristics of this tube make it suitable for use as an amplifier of the output of a sweep oscillator such as the
(Continued on following page)

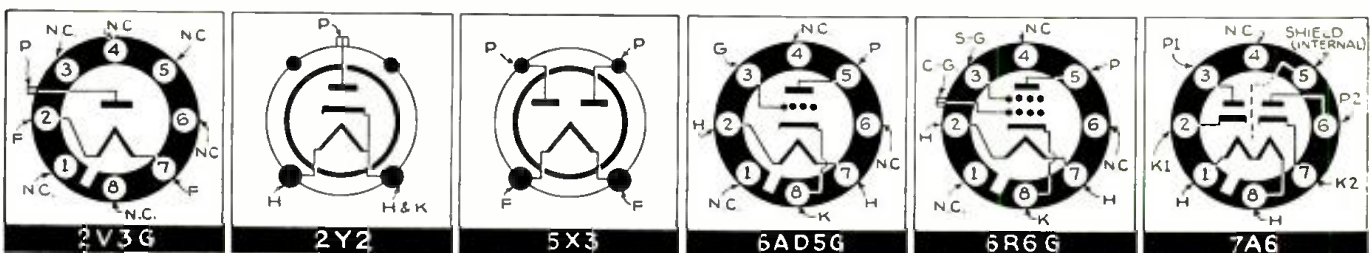

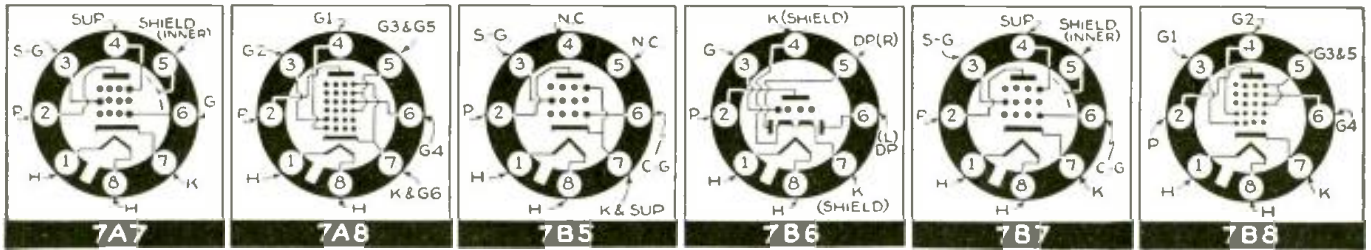

48 NEW TUBES

(CONTINUED)

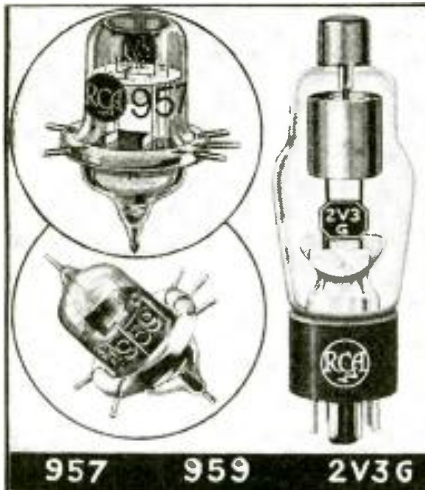
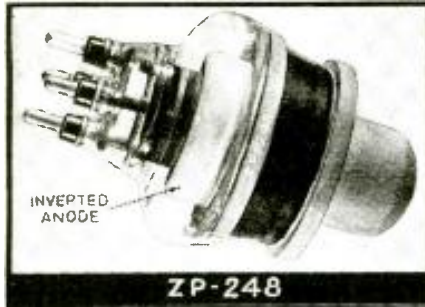

6AD5G. Advantage is taken of the shape of its grid voltage, plate current curve to compensate for the non-linearity of the output of the sweep oscillator and produce a resultant linear sawtooth wave for cathode-ray oscilloscope and television sweep circuits. The 6R6G is especially insulated to withstand high surge voltages, but the plate dissipation must be limited by a series protective resistor.

Characteristics—Table XXIII.

Through transmitting and cathode-ray tube distributors RCA Manufacturing Co., Inc., RCA Radiotron Division, is making available to the amateur and experimenter in television several types of cathode-ray and associated-type tubes. The first group of 4 tubes includes 3 Kinescopes (cathode-ray television receiving tubes), each of the electrostatic-deflection type, for television reception and a Monoscope or "picture" (not "image") tube for television testing.

The second group of 3 tubes includes 2 more kinescopes, but of the electromagnetic-deflection type, and a high-voltage rectifier.

In connection with the kinescopes it will be noticed that a suffix P has been added to the tube number. This makes it convenient to identify the type of phosphor (phosphorescent material) used on the screen at the end of the tube.

906-P4 Kinescope—3-in. Electrostatic-Deflection type, with Medium-Persistence White Phosphor

Except for its phosphor, which results in a black/white image, this small C.-R. tube (which may be used in either oscilloscopes or in television receivers) is identical with the type 906 of the same make.

Tentative characteristics—Table XXIV.

1802-P1 Kinescope—5-in. Electrostatic-Deflection type, with Medium-Persistence Green Phosphor

This medium-size C.-R. television receiving tube has high deflection sensitivity and is admirably suited by its black/green (highly actinic or photogenic) image for oscillographic work. A large 11-in. or "magnal" base is used. This construction, by grouping all connections at one end of the tube and thus eliminating cap leads, affords simplified wiring and increased protection from high voltages. Tube is also

suitable for television. Overall length, about 16 3/4 ins.

Characteristics—Table XXV.

1802-P4 Kinescope—5-in. Electrostatic-Deflection type, with Medium-Persistence White Phosphor

This television tube except for its phosphor is identical to the type 1802-P1. It is particularly suitable for television and oscilloscopic work, but less ideal than the 1802-P1 for oscillographic use. Image size is about 3 x 4 ins.

Tentative characteristics—(Identical with 1802-P1, which see.)

1899 Monoscope—5-in. Electromagnetic-Deflection type Signal-Generator Cathode-Ray Test-Pattern Tube

A permanent, 3 x 4 in. geometrical and picture pattern on the end of this tube is scanned by the flying spot of the cathode-ray beam. This produces a video signal of the test picture or pattern built into the tube, and is intended for use primarily in testing the performance of television equipment and for demonstrating television principles. The tube is also suitable for use in other signal-generator applications because it can generate square-top waves of controllable frequency.

Features of the pattern include calibrated resolution wedges to indicate the amount of detail the associated equipment can resolve, and tests for linearity of scanning, spot defocusing, amplitude, frequency, phase response, and (by means of the Indian head) general quality of picture reproduction. The 1899 has the ability to resolve 500-line detail in its pattern and still provide an output having high signal-to-noise ratio. Because of this feature, the 1899 is especially suited for testing the performance of 441-line equipment.

The pattern is so printed on the flat metallic electrode on the inside of the glass envelope, on the end, that the electron beam causes more secondary emission from white portions than from black portions. The collector is a conductive coating on the inner surface of the tube walls. It is operated at a positive voltage with respect to the pattern electrode and, therefore, collects practically all the secondary electrons emitted from the pattern electrode. When the beam

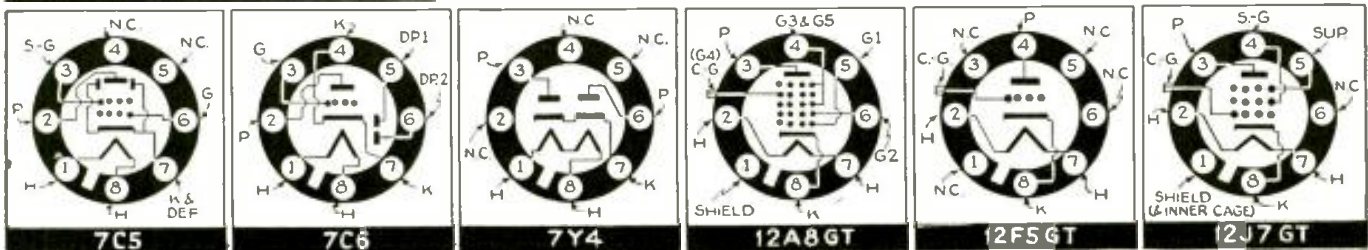

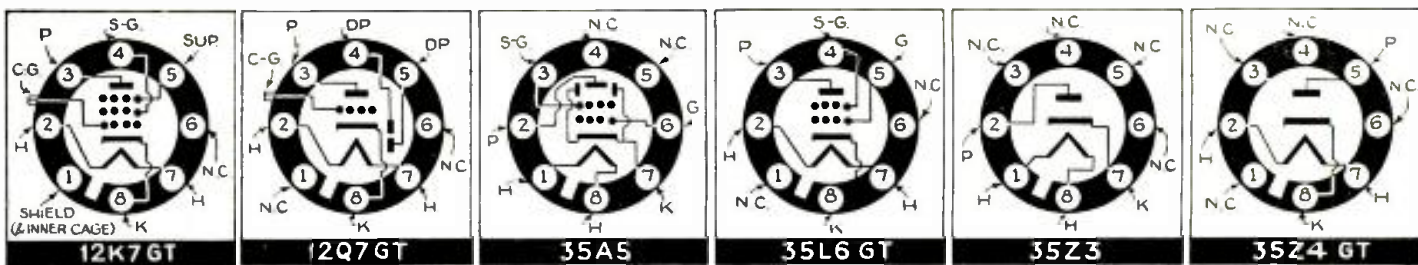

is made to scan only part of the pattern, the beam current should be made small, or reduced scanning should be used only for a short time, to prevent damage to the pattern.

A kinescope yoke (stock No. 9831, or equivalent) is suitable for use with the 1899.

A shielding case for the type 1899 pattern tube is required, in most installations. Its function is to prevent stray electric and magnetic fields from deflecting and defocusing the electron beam. When an iron or steel case is used, it should have very small residual magnetization.

The case should have a wall shielding the pattern electrode from the electrostatic field of the yoke. The purpose of this wall is to minimize pick-up by the pattern electrode and video amplifier of high-frequency components of the voltages across the yoke. It is desirable that the walls of the shielding case should be spaced not less than about 2 ins. away from the pattern electrode and its terminal. Closer spacing between the shield and the electrode may make the output capacity of the tube so large as to cause serious reduction in output voltage at high frequencies.

For testing television receivers, an extremely useful device is an ultra-high frequency oscillator modulated with the amplifier output of this television-test tube. The 1899 provides a test of the receiver's whole image channel, from antenna to receiving C.-R. tube.

Tentative characteristics—Table XXVI.

1803-P4 Kinescope—12-in. Electromagnetic-Deflection type with White Phosphor

This high-vacuum type of C.-R. television receiving tube provides an image of about 7½ x 10 ins. The fluorescent material permits a brilliant reproduction in black and white of the televised object.

This new tube operates with a maximum anode No. 2 voltage of 7,000 V., and has a grid No. 1 signal-swing voltage of approximately 25 V. for optimum picture contrast.

An important feature of the 1803-P4 is its glass bulb which has been shaped to give a minimum of reflection from the bulb walls and to provide a maximum of strength. The pressed face plate of the bulb provides high optical quality.

Tentative characteristics—Table XXVII.

1804-P4 Kinescope—9-in. Electromagnetic-Deflection type with White Phosphor

This tube except for the smaller screen is similar to the 1803-P4 C.-R. television tube. Its screen gives a black/white image

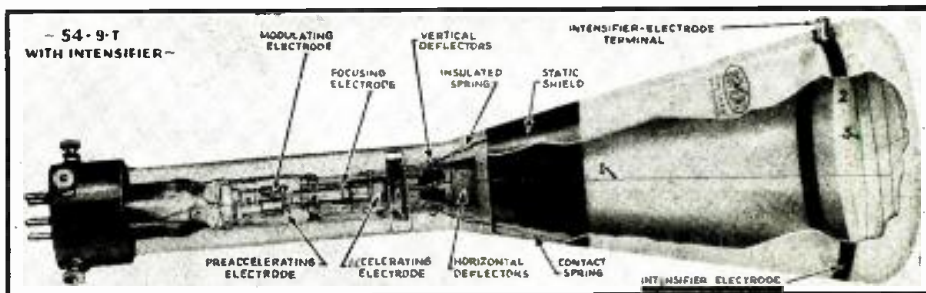

of about 5½ x 7½ ins.

Tentative characteristics—Table XXVIII.

2V3G—Tungsten-filament type of High-Vacuum, Half-Wave Rectifier

This tube is suitable for use in rectifying devices to supply the high D.C. voltages required by kinescopes and cathode-ray tubes. It has a maximum peak inverse voltage rating of 16,500 V. and a maximum peak plate current rating of 2 ma. The 2V3G can also be used in voltage-doubler service to deliver approximately twice the voltage obtainable from it in half-wave or full-wave rectifier service for the same A.C. input voltage.

The base of the 2V3G fits the standard octal socket. The socket should be mounted to hold the tube in a vertical position with the base either up or down. Only a socket capable of carrying 5A. should be used. The plate connection is made to the cap at the top of the bulb. The bulb becomes hot during operation of the tube. Sufficient ventilation should be provided to prevent overheating.

Caution should be observed when the filament voltage is measured because the filament circuit is at high D.C. potential.

Tentative characteristics—Table XXIX.

"STUBBY" TELEVISION TUBES; PATTERN TUBE

Last month National Union Radio Corp. announced the addition of 3 more tubes to their line of television tubes. Two of these are Videotrons (National Union television receiving tubes) which feature foreshortened construction; the third is a Monotron (National Union's trade name for a television pattern tube) featuring use of a picture as having advantages over a geometrical pattern.

1805-P4 "Stubby" Videotron—5-in. Electrostatic Deflection, Black/White C.-R. Television Receiving Tube

This tube is illustrated in comparison with a "standard" or long tube of the



"5-in." class; the newer tube, 13 ins. long, is 3½ ins. shorter than its parent tube. The 1805-P4 is lined with aquadag—a conductive coating which does not permit the light beams to ricochet inside the tube; the non-reflecting interior thus assures even, clean-cut image tones on the tube's screen. A symbol for this tube has not yet been released.

Characteristics—Unannounced.

9-in. "Stubby" Videotron (Number Unassigned)—9-in. Electrostatic Deflection, Black/White C.-R. Television Receiving Tube

The "stubby" 9-in. tube offers the same-size image in a tube only 16 ins. long, previously available only from a tube 23-ins. long.

This length reduction permits the much desired combination of small cabinet televisions and large-screen images. The tube can be mounted horizontally in a shallow cabinet permitting direct viewing rather than by the mirror-lid reflection method necessitated by vertical "towards-the-ceiling" mounting. The ratio of the large im-

(Continued on page 682)

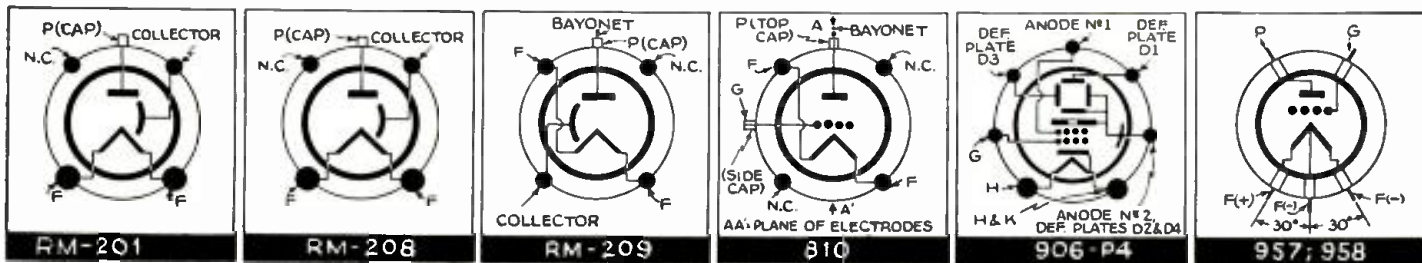

D. C. TO A. C. CONVERSION

Technical advances during the last couple years in the construction of polarity-changing voltage regulation, about 95%; frequency regulation, 100% ($\pm \frac{1}{4}$ -cycle throughout the interference production (less than a rotary converter commutator ripple); wide range of

WILLIAM W.

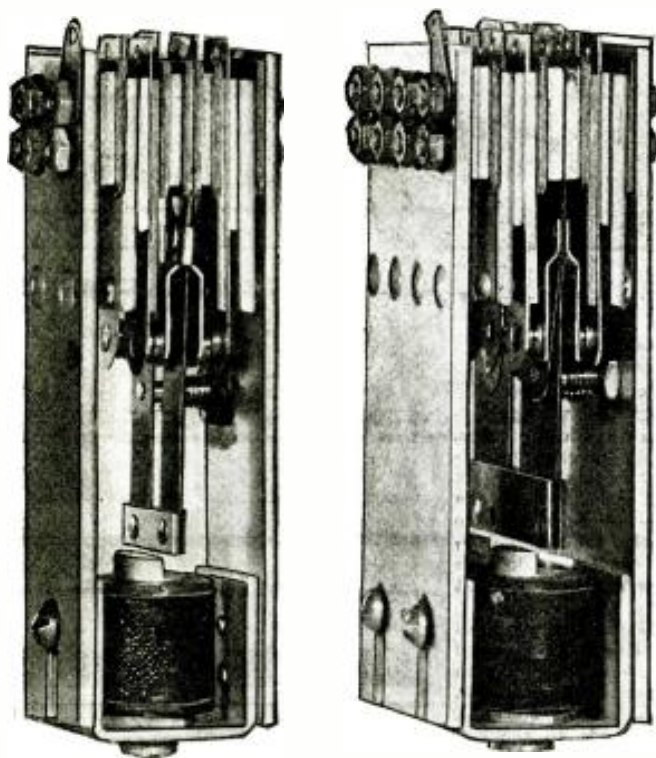

Fig. A. Types of vibrators. 1—A 200- to 300-W. 8-contact unit. 2—A 500- to 600-W. 16-contact vibrator. Increased current capacity is obtained by the use of multiple contact points connected in parallel.

DIRECT current districts still exist in 80 of the largest cities of the country. Consequently it is of prime importance to provide some method of converting direct current to alternating current so that standard A.C. equipment may be used on D.C. lines.

There of course have been many methods used in the past for providing this conversion, the most common of these, until recent years, having been the rotary motor-generator set. Subsequently, a new type of D.C. to A.C. converter was placed on the market utilizing the principle of a vibrating reed actuating the center-tapped primary winding of a transformer. By means of the vibrating reed the two halves of the primary winding of the transformer were alternately actuated by direct current, the flow of current being in opposite directions, thus producing in the secondary winding of the transformer, an alternating current suitable for the operation of A.C. devices. Although highly practical and quite efficient, and much smaller in size than the rotary converter, this unit was still too bulky for the operation of small equipment such as electric clocks, etc. With the further development and improvement of the vibrator-type switches a new method was adopted for providing D.C. to A.C. conversion. It is this method which is the subject of this article.

THE D.P.D.T. SWITCH

In the field of electric art, in physics laboratories, and in research departments,

there probably is no mechanical device more common than a double-pole double-throw (D.P.D.T.) switch.

Undoubtedly every electrical engineer has many times in his course of training and in his practical work placed his hand on the handle of a double-pole switch and has thrown it in the opposite direction in order to reverse the polarity of the device that he was testing. Undoubtedly numerous of these individuals have desired to be able to move their hand so rapidly back and forth that they could throw that switch 60 times a second and thus reverse that polarity rapidly enough in order to produce a usable alternating current. Attempts have been made in the past to do this function by means of commutators on a rotating shaft. Efforts also were made to drive an actual switch mechanism by means of a rotating eccentric but disadvantages invariably appeared which thwarted the efforts to produce a usable alternating current.

Recently utilizing the principle of a vibrating reed and profiting by the experience of many years in the design of heavy-duty multiple-contact vibrator elements a new type of vibrating double-pole double-throw switch was developed to provide the first practical polarity-changer converter for the conversion of direct current to alternating current.

POLARITY CHANGER

In order to understand the function of a polarity changer it is possible to trace

the path of the current in the circuit shown in Fig. 1. Contactors *x* and *y* being vibrating reeds, alternately engage *a* and *b*, and *c* and *d*, respectively—in other words, when *x* is engaging *a*, *y* will also engage *c*, and when *x* engages *b*, *y* will also engage *d*.

Following the path of current from the positive side of the direct-current line at a time when *x* is in engagement with *a* and *y* is in engagement with *c*, it will be seen that the current passes through *x* and through *a*, thus making terminal *f* of the A.C. output positive. At the same time, tracing the path of the current from the negative side of the direct-current line, we find that it passes through *y* and *c*, thus making terminal *e* of the alternating current output negative.

If these contacts now open and the reed swings in the opposite direction so that *x* engages *b*, and *y* engages *d*, and if we again trace the path of current from the positive side of the direct-current line, we find that it passes through *x* and *b*, and makes terminal *e* of the alternating current output positive and in the same manner, terminal *f* of the alternating current output negative. If *x* and *y* vibrate at a frequency of 60 cycles per second, the polarity of terminals *e* and *f* of the alternating current output will be reversed 60 times a second, thus providing us with alternating current, or, in other words, current whose polarity changes at a predetermined frequency produced from a direct-current source.

It will of course, be noted in this system of conversion that the output alternating current will be essentially the same in voltage as the direct current input voltage. The loss through the contact points is relatively small provided the correct design and material is used in making the vibrating switch.

Numerous methods can be used for driving the vibrating reed and the most practical methods will be shown in later circuits.

TYPICAL VIBRATOR

A typical polarity-changer vibrator is illustrated in Fig. A1.

This unit is equipped with 8 power-carrying contact points and with 2 auxiliary contact points for driving the vibrating member. The two vibrating members are connected together by means of an insulating strap fastened at one end. It will be noted that the vibrator is of the same general construction as the split-reed synchronous vibrator as used in farm-radio receivers for the interruption and synchronous rectification of battery current.

This vibrator is capable of handling between 200 and 300 watts when operated on a 110-volt direct current circuit. Figure A2 shows a larger vibrator capable of handling approximately 500 to 600 watts on a 110-volt circuit and it will be noted that this vibrator has 16 contact points and that the points are paralleled in order to give greater current-carrying capacity.

In order to show the actual commercial application of this type of device Fig. 2 illustrates a vibrator polarity changer operat-

—Using Polarity Changers

converters have resulted in vibrator-type units with standard efficiencies from 85 to 95% (range of input voltages); and output waveforms of almost any desired shape; slight power factors; frequency controllable to $\pm 2\%$; and power outputs up to 500 watts.

GARSTANG

ing a small synchronous motor of the type generally used in electric clocks and time regulating equipment. In this particular instance, the load on the polarity changer is the inductance of the clock winding.

CONDENSER C1

A basic polarity changer circuit is illustrated in Fig. 3 showing the values of the component parts of the circuit for various input voltages.

Condenser C1 in the circuit, is provided for the power factor correction of the A.C. load. This is essential in any vibrator-type converter circuit and will be readily recognized when it is considered that the "buffer condenser" in an auto-radio power supply circuit performs the same function.

In order to provide long life of the contact points, a vibrator interrupter must be operated so that the current at the time that the points make and break is practically zero. This condition can be met only if the device is operated in conjunction with a resistance load or a load having the same electrical characteristics. Inasmuch as the resistance load has unity power factor, it is a necessary essential to provide approximately the same power factor on any alternating current load to be operated. Consequently, if the load to be operated is inductive (such as is ordinarily encountered with synchronous motors, transformers, and other similar equipment), it is necessary to add sufficient capacity in shunt across the load in order to balance the inductive reactance of the load with the capacitive reactance of the condenser. As a result of this explanation, it can be seen that condenser C1 is a variable function depending upon the load characteristics. There are 4 condensers in the circuit indicated as C, these being placed across the contact points, and their purpose being to absorb any slight sparking that might occur at the points during operation.

RESISTOR R1

Resistance R1 is placed in the circuit in order to limit the peak value of the current during the operation of the device.

Its value should not be sufficient to materially injure the regulation or efficiency of the unit but must be of such a value to limit the peak value of the current to the rating of the contact points. In a vibrator of this type the power-carrying points are of tungsten and the actuating points for driving the vibrator mechanism are of silver. In order to provide long life of these silver contact points, resistor R2 is placed in series with a small condenser across the contact points in order to absorb any derogatory surges that might occur to damage the points.

RESISTOR R

An unusual feature in vibrator converters is the fact that the frequency can be varied within a narrow limit (± 2 cycles, approx.); this variation can be accomplished electrically although the electrical variation produces, in turn, a mechanical variation in the amplitude of the vibrating reed.

Resistor R in the circuit is variable and varies the pull exerted by the actuating coil on the armature of the vibrating member. The variation in pull of the actuating coil varies the amplitude of vibration of the reed, thus causing a slight change in frequency in direct proportion to the variation of resistance. This feature is extremely desirable when the device is operating electric clock motors and provides a means of adjusting the time kept by the clock in the same manner that a watch would be adjusted!

The frequency regulation of this type of converter is one of its prime features. The frequency will remain constant to within 1 part in 300 with a line voltage variation of 15%. With a constant input line voltage the frequency will remain accurate to a tolerance of plus or minus 0.05%. No other converter, of any type, will provide frequency regulation even approaching this standard.

A commercial example of this polarity changer is illustrated in Fig. 4. It will be noted in the circuit that additional chokes and condensers have been inserted in order to provide a filter so that this unit may

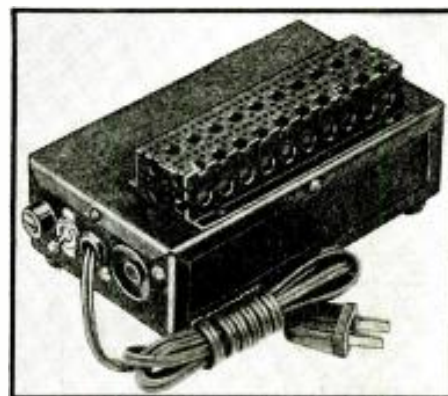

Fig. B. Here is illustrated a complete 110-V. D.C. to 110-V. A.C. polarity changer converter with an output rating of 250 W. (Electronic Labs. model 833).

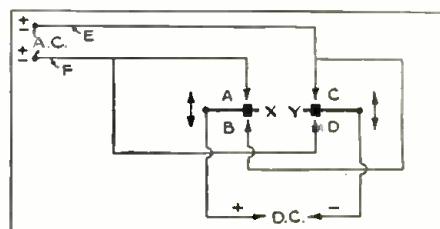

Fig. 1. Functional diagram of a polarity changer.

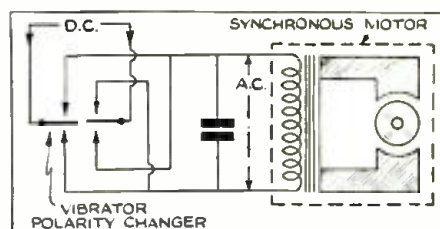

Fig. 2. Vibrator polarity changer operating a clock-type synchronous motor.

operate amplifiers and public address systems. This unit is illustrated in Fig. B, its total weight being less than 3 lbs., and its capacity 250 watts. This unit is not super (Continued on page 681)

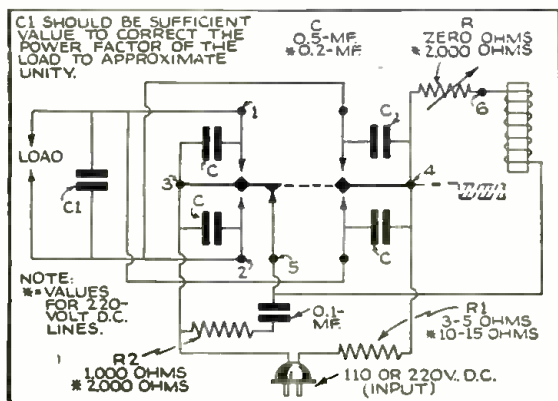

Fig. 3. Basic polarity changer circuit. Parts values for various input voltages are given.

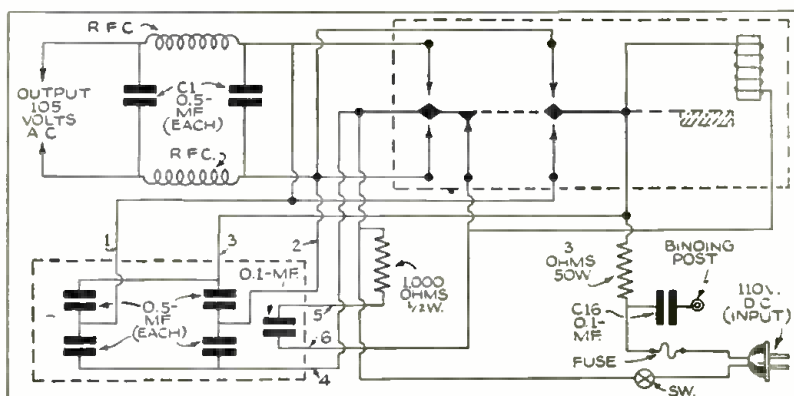

Fig. 4. A commercial type of polarity changer incorporating controllable frequency variation of about 2 cycles.

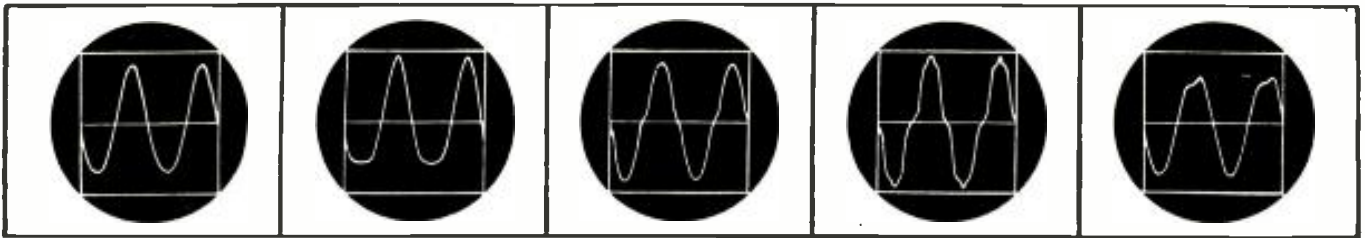

Fig. 10A. 10% 2nd-harmonic distortion. Note the dissymmetry: sharp positive and rounded negative peaks.

Fig. 10B. 25% 2nd-harmonic distortion. Defects in single-ended circuits, such as too low a plate load, are the cause.

Fig. 10C. 10% 3rd-harmonic distortion. Both positive and negative halves of wave, are symmetrically peaked.

Fig. 10D. 25% 3rd-harmonic distortion. Possible cause: excessive grid-bias in the push-pull stage.

Fig. 10E. Grid-circuit overload in a single-tube circuit.

Complete Step-by-Step DYNAMIC SERVICING

What is Dynamic Servicing?—See how many of your associates in the service field can answer this question! Then read this article and see how this test procedure can increase your earning power by speeding your radio service work.

KENDALL CLOUGH

PART V (Conclusion)

Section 10

TESTING THE AUDIO CIRCUITS FOR DISTORTION

SOURCE OF TESTING VOLTAGE

If your Signal Generator meets the tests described in Part IV under the title of "Alignment of A.F.C. Circuits," and has a connection for obtaining 400-cycle audio voltage from the internal oscillator, it will serve for this test. In any event, the audio voltage used must be of good sinusoidal shape, as viewed on the oscilloscope.

CONNECTIONS

Connect the VERT. posts of the oscilloscope across the voice coil of the speaker.

The source of audio voltage should be connected from the chassis to the high side of the audio volume control, using a 0.5-mf. condenser in series.

SETTING THE CONTROLS

Turn the CONTROL knob to EXT. (external), and connect the EXT. SYNC. post to the high side of the audio generator circuit.

Turn the volume control up enough to give a small response from the speaker and turn up the VERTICAL amplifier control enough to get a pattern. Adjust the FREQUENCY and VERNIER knobs to get 3 or 4 complete pattern cycles on the screen, and turn up

the SYNC. control just enough to lock the pattern.

Now advance the volume control slowly, and at the same time retard the VERTICAL amplifier control sufficiently to keep the pattern at constant

ELECTRODYNAMIC SPEAKERS HORACE L. BURNS

THE Amateur and Serviceman are interested in 3 acoustic characteristics in modern dynamic loudspeakers. They are sensitivity, distortion, and cut-off frequency.

The *sensitivity* is the intensity of sound produced by the loudspeaker for a certain amount of electrical energy fed into the input. High sensitivity is obtained by causing an intense magnetic field in the air gap in which the voice coil works; having the voice coil close to the field core (with a clearance of not more than a few thousandths of an inch); and by designing the reproducer with a center core leg and shell of high-grade magnetic steel. The efficiency of a good-grade speaker of this type is about 5%. The cheaper grades vary from 2 to 4%.

The amount of *distortion* is the difference between the electrical wave fed into the loudspeaker and the sound wave produced by the speaker. The distortion is kept low by having properly filtered current in the field, thus keeping out a 60- and 120-cycle hum; having the cone properly centered and constructed of the proper material; and, having an intense magnetic flux in the air gap. Of course the speaker must not be overloaded at any time or distortion will result.

The *cut-off frequency* constitutes points on the high and low frequencies above and below which the speaker will not produce sound waves efficiently. The average 8-inch speaker will reproduce notes as low as 30 cycles and as high as 6,000 cycles. For good reproduction of music a frequency range from 80 cycles to 10,000 cycles is necessary.

This shows that the speaker used in the medium-priced radio set will not allow high-fidelity reception. It is very easy to build a radio receiver that will handle any necessary frequency range. It may be done by using resistance-capacity coupling in the audio circuit; but with the type of speakers in use today it is useless to build such a circuit.

When speakers that are 50 to 80% efficient, become a commercial possibility, it will change the entire field of radio.

A 50%-efficient speaker could be connected directly to a magnetic pickup and would deliver normal room volume!

height. The trace should remain sinusoidal (see Fig. 1D in Part I) up to the maximum power output of the receiver.

SYMMETRICAL AND UNSYMMETRICAL WAVES

It is valuable in the identification of distortion to keep the following principle in mind:—

Odd-harmonic distortion, arising from 3rd, 5th, etc., harmonics, always gives a wave pattern which is symmetrical on both sides of the axis.

Even-harmonic distortion, from 2nd, 4th, etc., harmonics, always makes the wave unsymmetrical with respect to the center axis.

The patterns of Figs. 10A, B, C, and D illustrate this principle. In actual distortion there is always present more than one harmonic, but these patterns show the effect of the principal ones, the 2nd and 3rd, when present in the amounts of 10% and 25%.

IDENTIFICATION OF DISTORTION

It follows from the above that symmetrical distortion will be produced by a circuit defect which is common to both tubes of a push-pull circuit. For example, excessive bias on a push-pull tube will produce the distortion in Figs. 10C and 10D.

Other forms of distortion and notes
(Continued on page 696)

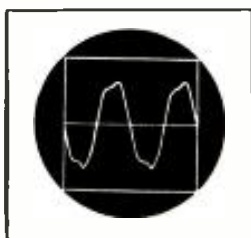

Fig. 10F. Grid overload in a push-pull circuit. Note symmetry of positive and negative halves of waveform.

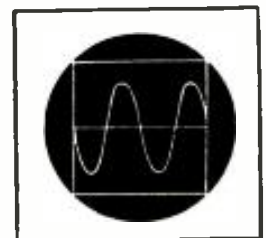

Fig. 10G. Symmetrical distortion caused by too low a plate load in a push-pull circuit. Compare with Fig. 10A.

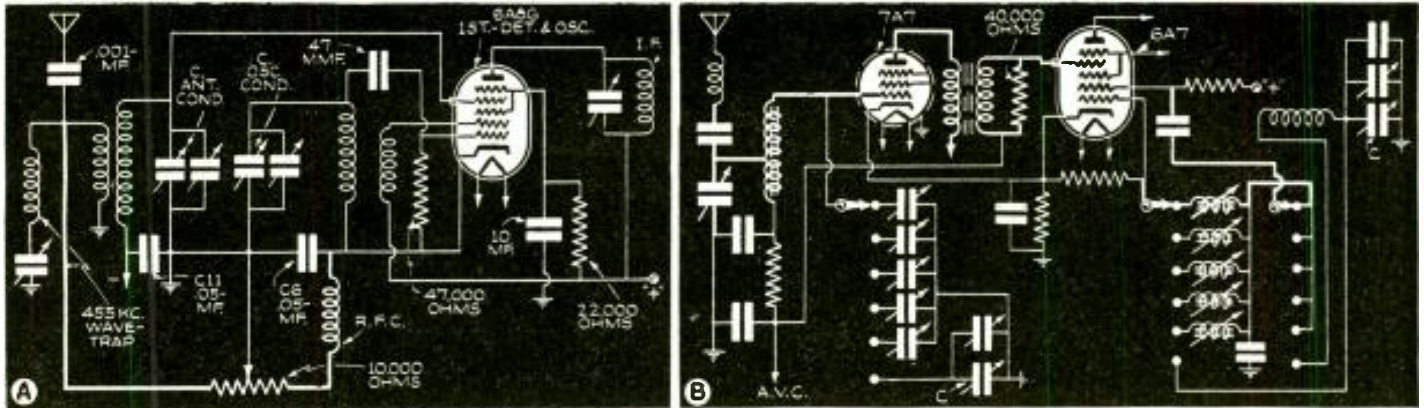

Fig. 1. New circuit features of (A) General Electric Model GD-51; and (B) Philco Model 937.

NEW CIRCUITS IN MODERN RADIO RECEIVERS

The details of the modern radio receiver circuits that make them "different" from previous designs are illustrated and described each month by a well-known technician.

F. L. SPRAYBERRY

NUMBER 20

(1) BIAS CONTROL OF DETECTOR-OSCILLATOR STAGE

General Electric Model GD-51. The antenna bias type of control is used on this receiver as it has but 2 detectors and a power amplifier in its signal circuit.

The circuit is shown in Fig. 1A. The rotors of the tuning condensers are, of course, grounded as usual and the antenna and oscillator resonant circuits must be completed through low-reactance condensers so that the D.C. values supplied to the signal control-grid and cathode will not be grounded. The R.F. drop across C11 is easily filtered by a high resistance (not shown) connecting the 1st-detector signal grid-return to the point when the bias voltage is applied. There is a much larger drop across C6 at the frequency of the oscillator and this cannot be filtered with a resistor of high value, because all the cathode current must be carried by the resistor at a rather low maximum cathode voltage. Hence an R.F. choke, R.F.C., is used in series with the cathode so that the oscillator frequency will not change with adjustments of the volume control and good filter action is obtained.

(2) UNTUNED DETECTOR INPUT STAGES

Philco Model 937. Preceded by a grid-tuned R.F. stage using a "filled core" R.F. transformer, this receiver uses an untuned detector input thus greatly simplifying the pushbutton tuning arrangement.

By arranging the circuit as in Fig. 1B, the advantage in gain due to an R.F. stage is gained without complicating the pushbutton apparatus. The R.F. grid and oscillator are the only R.F. tuned circuits, the former making use of individual trimmers and the latter making use of adjustable-core coils. The coils are wired in a "2-control" oscillator, so-called because the coil is not tapped and there is no inductive feedback.

The R.F. grid input coil operates as an autotransformer, while the R.F. coupling transformer is untuned and has a core of magnetic material. The coupling in this way is nearly constant and quite large, and the resistor across its secondary serves to hold its impedance fairly constant within the broadcast band of frequencies.

The R.F. gain-leveling resistor is the 40,000-ohm unit shown in Fig. 1B.

(3) UNUSUAL ANTENNA INPUT FILTER SYSTEM

Stewart-Warner Models 41-82, 98-82, 910-82. This receiver employs a very complete filter system which minimizes image interference and interference on the I.F. band, and yet is not critical to the type of antenna used.

By a very ingenious choice of values in this circuit it is possible to realize very complete filtering. Referring to Fig. 2A, the combination 65a, 24, the lower section of 65b and 63-45, the lower section of 65b and 63-45 is resonant to 600 kc. to boost the low frequencies, and thus make the response in the broadcast band more uniform. Condenser 24 with coil 65a alone forms a rejection circuit at 2.5 mc. to eliminate upper-image interference. Coil 65b with condensers 63 and 45 is tuned to the I.F. so that this frequency will be shunted out of the circuit. Coil 65c with pushbutton condenser 55b tunes approximately 930 kc. above the signal (twice 465 kc.) for image rejection. Condenser 48 is simply a tracking condenser with a value such that all pushbutton condensers as 55b will track at 930 kc. above the signal. Its function

(Continued on page 693)

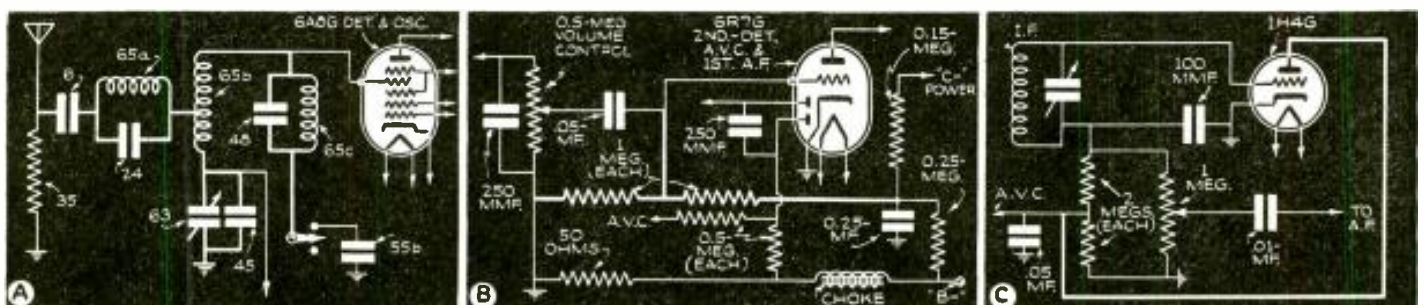
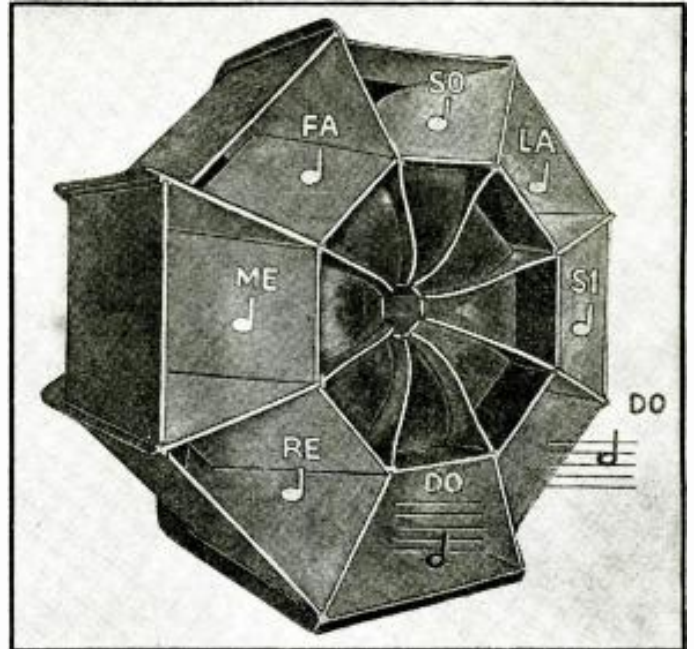
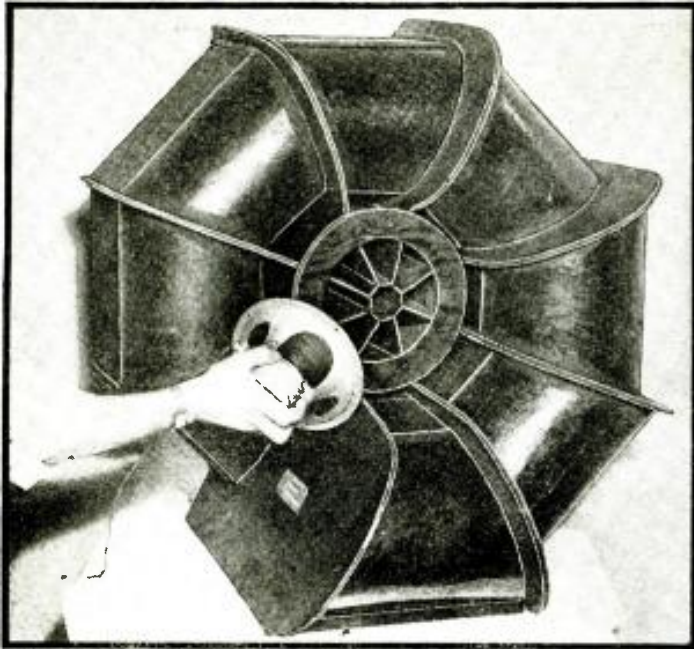

Fig. 2. Circuit features of (A) Stewart-Warner models 41-82, 98-82, 910-82; (B) Goodyear Model 01501; (C) Airline models 62-550, 62-1550, 62-2550.



Sound from an 8-in. dynamic speaker put in here, goes back and forth and comes out here!; resonance tends to assist low-register reproduction.

AN "Octave-Resonance" MULTIPLE

RADIO-CRAFT brings you another "first"! Patents granted and pending seem to indicate
duction, as compared to previous baffle constructions, through the use of a baffle system

WILLIAM R.

THE conventional type loudspeaker consists of a movable cone actuated by electrical impulses on a small voice coil attached to the movable cone. These electrical impulses cause the loudspeaker cone to be moved back and forth; and thus, to generate sound waves from the cone. There is much speculation as to how a single vibrating body such as the loudspeaker cone is able to reproduce a complex tone pattern such as made by a number of musical instruments. It has been proved by electrical measuring devices, however, that the loudspeaker *can* and *does* reproduce all tones.

OVERTONES

We come to wonder why electrical reproduction always sounds "flat" and the full orchestration is only heard in part. What has become of the full-throated orchestra tone pattern as was originally intended, by the composer, through blending of several instruments?

The trouble lies in the inability of the loudspeaker to accurately reproduce the *overtones*. The overtones give any musical instrument its characteristic tone. A violin has the same shape



as the bass fiddle but has a different set of overtones; result: the violin is easily identified by its own, characteristic tone. All other musical instruments have their own, and *characteristic*, overtones. Some instruments have as many as 10 to 20 overtones, the more overtones the finer the instrument. This is what makes a Stradivarius different from a common violin.

In the manufacture of loudspeakers they are tested by impressing a single tone into the unit and varying the frequency of the tone. Characteristics of the speaker's performance are then determined by measurement in an extremely sensitive apparatus. The picture obtained in this manner shows up well on a single tone input, but a complex wave input tells a different story!

The high frequencies tend to react in a band close to the center of the cone and become very directional, while the low frequencies react on a greater surface of the cone. By damping the back of the speaker cone by a suitable enclosure the tone is improved but this enclosure becomes resonant and results in distortion of a limited band of frequencies.

EFFICIENCIES

An orchestra consisting of 15 instruments would be generating a complex tone pattern of 15 basic tones combined with 15 sets of characteristic overtones (or *harmonics* as they are sometimes referred to). A total of several hundred tones would then be present. These tones all are impressed upon the microphone instantaneously. The "mike" is a featherweight metal diaphragm and is working into a medium 892,800 times more efficient than air. (Electricity is 892,800 times "faster" than sound.) A "mike" can transmit such a tone pattern into electrical impulses and electrically there should be no trouble at all.

The loudspeaker cone on the other hand is bulky and is working from a high-efficiency medium into an ultra-low efficiency medium such as air, and the result is that the tones are chopped off sharp and short due to the inability of the cone structure to sustain all tone frequencies simultaneously.

The loudspeaker must not favor any certain tone and the low frequencies, having a long vibrating interval, are sounded several times during their duration. Each of these intervals of reaction is sharp and short, and is not held an interval of time long enough for our ear (a poor receiver) to recognize it.

THE AUTHOR CLAIMS THAT THIS BAFFLE:

- 1—assists the loudspeaker in reproducing the full range of musical frequencies.
- 2—is free from low-frequency resonance points usually encountered in conventional-type enclosures.
- 3—increases loudspeaker efficiency on all frequencies.
- 4—has desirable directional characteristics.
- 5—is a musical instrument rather than a board.
- 6—increases the power-handling capacity of loudspeakers.
- 7—consists of 8 air columns, each tuned to one of the 8 fundamental notes in the lowest octave to which the loudspeaker will respond.

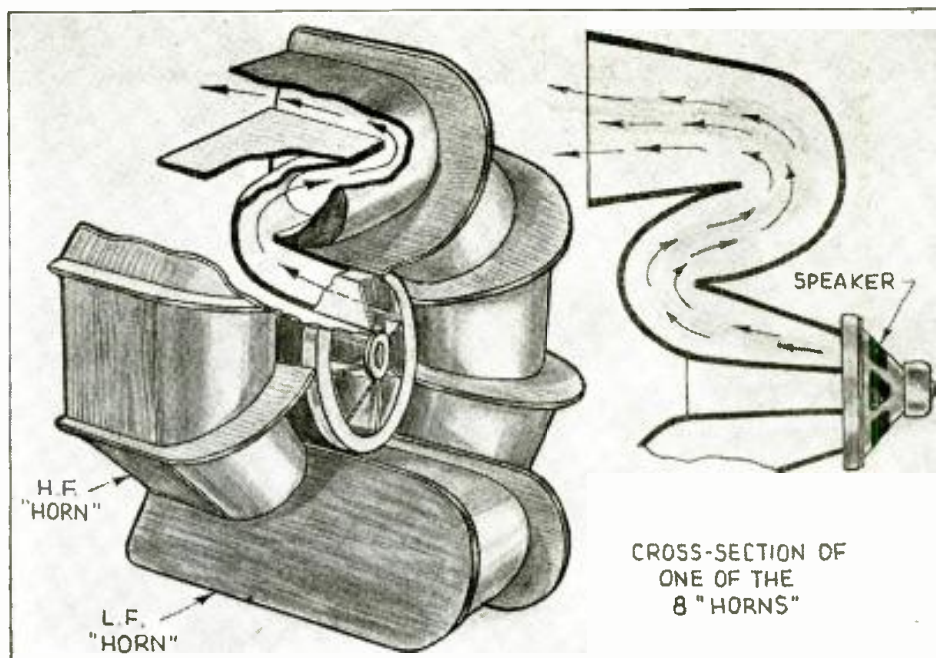

This breakaway view shows the unique, zig-zag form of Mr. Allison's octave-resonance baffle.

AIR-COLUMN BAFFLE

that Mr. Allison really "has something" in his system for obtaining more natural reproduction broadly resonant to the fundamental frequency range of the speaker with which it is used.

ALLISON

Let us assume that the loudspeaker does reproduce all frequencies and overtones, even though we cannot distinguish them. Let us study the characteristics of amplification by *resonant air columns*.

OCTAVE RESONANCE

We know that a tuned air column will reinforce a basic frequency and all overtones of the basic frequency. The unique construction of the Octave Resonance, multiple air-column baffle, enables a full octave of resonant air-columns to be loaded directly onto the loudspeaker cone. This provides perfect loading or damping at all frequencies.

Not only through perfect loading is the original purpose of the baffle realized but in addition thereto an increased efficiency of the speaker unit itself is obtained. In laboratory tests the efficiency percentages of some loudspeakers were increased as much as 30 per cent through the use of this particular baffle. In itself this feature is to be by no means overlooked. Particularly when we realize that the present-day loudspeakers of only the very best type have an efficiency of less than 40 per cent.

Fundamentally the unit is based entirely on a principle which for many years has been accepted by the musical world but has hitherto not been applied to loudspeaker performance. The Octave

Resonance Baffle consists of a group of 8 chambers or pipes originating at the cone of the loudspeaker; each pipe is arranged to obtain $\frac{1}{8}$ of the sound pressure from the excited cone. These pipes are so constructed as to be tuned to 8 fundamental frequencies on which all musical composition is based.

Being tuned (in a sense) to fundamental musical frequencies this new development in loudspeaker baffles tends to prolong, only to a desired degree, the lower tones of orchestral accompaniment. In this manner the full rich tones and overtones of the bass viol, tuba, etc., are fully developed in each's proper relation to other instruments.

Not only are the low-frequency instruments brought out in reproduction but also the high-frequency instruments are "helped." This is due to the fact that harmonically the unit extends the range to 9 times the fundamental range of the *piano* which is in the present-day world the fundamental instrument in any orchestral group. The human voice is reproduced accurately including all overtones. The human voice has properties similar to a musical instrument and faithful reproduction is obtained in the same manner as that required to reproduce a musical instrument.

Transverse vibrations within the tone chambers of the baffle do not interfere with each other during a period at

which two entirely different but related frequencies are being reproduced. This is attributed to the ability of each pipe to faithfully reproduce as many as 20 different musical tones so long as these tones are related to the fundamental frequency at which the pipe is tuned or are harmonics of that basic frequency.

"IN-BETWEEN" NOTES

The question will probably arise in the reader's mind as to whether "sharp" or "flat" tones would be reproduced.

Reproduction of any sharp or flat note is brought out through an uncanny relation of the chambers to each other so that the two chambers tuned to the frequency above and below the sharp or flat tone resonate but only at 50 per cent of the amplitude of a full pipe, had the tone been a fundamental. But the two chambers operating at 50 per cent amplitude and being in-phase, full 100 per cent amplitude is obtained.

Much has been said in the foregoing in regard to the manner in which the unit proves desirable when used with a cone-type speaker, but there is still another factor which is not to be overlooked. This factor will lend itself particularly to public address and theater installation where a concentrated source of sound is desired.

This is principally due to the uni-
(Continued on page 693)

A Chandelier SPEAKER BAFFLE

The latest development in speaker baffles is the new "Chandelier"-type baffle that spreads or disperses sound, over a 360° area, with uniform intensity.

R. C. REINHARDT



The "chandelier" speaker baffle installed in a typical dance hall directly over the spot from which the master of ceremonies makes his announcements.

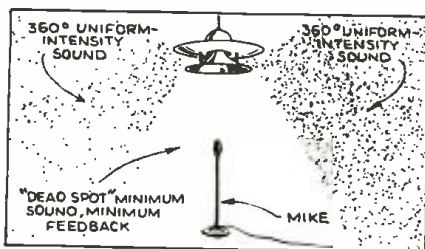

The sound radiates from the periphery of the baffle over an area of 360 degrees—or, stated simply, in all directions. The sound intensity is uniform.

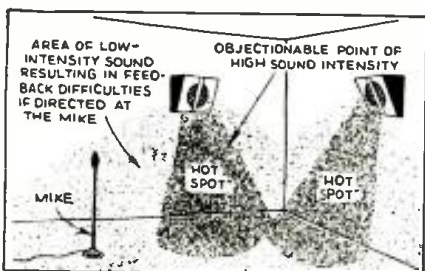

The use of multiple speakers in a room creates interaction of sound which causes so-called "hot spot" or high-sound-intensity areas.

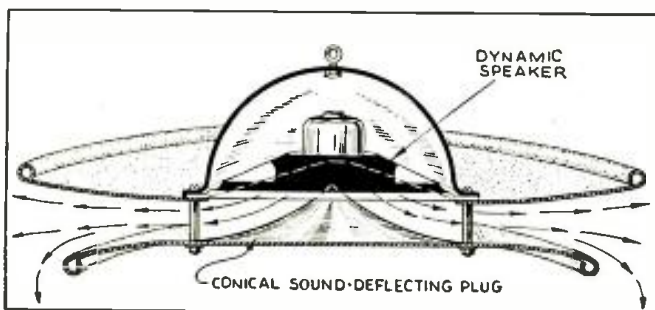

Constructional details of the chandelier baffle showing the speaker in place. Note that there is virtually no radiation directly beneath the baffle.

A NEW type of speaker baffle, which in location and appearance suggests a "chandelier," has just been introduced which solves several acoustic problems that have troubled sound engineers for many years. The latest development in speaker baffles is the new "Chandelier"-type baffle that spreads or disperses sound, over a 360° area, with uniform intensity.

"HOT SPOTS"

The use of this "chandelier" speaker will, in many installations, eliminate the necessity of multiple speaker clusters, or a number of scattered wall baffles and speakers. Under present conditions, with multiple speaker arrangements, there is a constant source of annoyance in "hot spot" areas. Persons located in "hot spot" areas suffer from an extreme loudness effect and usually place the blame on the entire P.A. system.

The illusion created by the chandelier speaker baffle is most desirable inasmuch as the sound originates from a source in close proximity to the microphone and not from a distantly located loudspeaker. With this favorable condition, the microphone can be brought out in the center of the room. The sound originates from the center of the room at the microphone and at the same time it is distributed from that same point by the loudspeaker mounted overhead.

"DEAD SPOT"

The new chandelier baffle not only eliminates disagreeable sound areas—but also creates an area of protection for the microphone—a "dead spot" area. If the microphone is placed in the "dead spot" under the baffle, directly on the speaker axis, a minimum amount of acoustic feedback will be experienced, permitting a maximum of sound amplification.

This is due to the fact that the output assumes maximum intensity in a peripheral pattern with reference to its axis. The use of the horn in this manner lends itself admirably for installations in clubs and cabarets where the necessity of projecting sound in close proximity to performers on the floor exists—thereby

retaining the natural illusion considered of such great value in show business.

The chandelier baffle also has its advantages in applications where acoustic feedback is not the main problem. In many P.A. applications it is not practical to mount a large number of individual speakers on wall surfaces. A typical example would be in locations where overhanging balconies and other obstructions would absorb or deflect the sound. In still other applications, the economy issue prevents the use of multiple speakers to obtain a uniform 360° coverage.

EFFICIENCY FACTOR

Other features and advantages not specifically enumerated will be apparent after a consideration of the following detailed description: It is conceded by most loudspeaker authorities that maximum sound pressure is present on the principal axis of the radiated sound pattern. This axis on conventional loudspeakers assumes a very small cross-sectional area with a resultant so-called "hot spot."

Where high sound levels are required and must be maintained at uniform sound pressures it becomes necessary to install more than one speaker unit. It will be apparent to the P.A. man that in order to reduce microphone feedback and to minimize the resultant periodic reverberation, volume levels must be kept low. This tends to reduce the overall efficiency of the sound reinforcing system being considered.

From the foregoing, it becomes apparent that if it were feasible to increase the effective area of the speaker's axial beam without introducing any undesirable effect that may influence the output characteristics, a unique and efficient speaker assembly would result.

By observation and laboratory tests it was found that inasmuch as the sound output assumed an annular pattern it could be concluded that the principal axis, having been dispersed by means of the conical, sound-deflecting plug at the speaker mouth, had now become a secondary axis in a peripheral plane (and the principal axis had become only a geometrical expression or reference).

It will be agreed that we have succeeded in increasing the efficient axial beam area so that it now effects a larger room area than has been heretofore possible with existing speaker equipment; this without resorting to the use of increased power input. Actual laboratory measurements show this speaker assembly to be 30 per cent more efficient than a similar speaker unit

(Continued on page 702)

OPERATING NOTES

Trouble with . . .

. . . PHILCO 37-33 MODEL

Many of these sets become inoperative on one end or over the whole dial. The trouble is due to the 1D7G tube circuit failing to oscillate without blocking. The 1D7G tube often tests perfectly. I have found many cases where the trouble existed in the 51,000 ohm resistor (No. 8 in schematics) from the ground to the oscillator coil; it was connected to osc. grid (No. 1 point of osc. coil in schematics) instead of ground side of osc. coil (No. 3 point of coil in schematics). After resistor is changed to proper place, no more trouble is experienced. The sets have much more volume. This seems to have been the original hookup or a mistake in assembly, because the ones that have been hooked-up right, in this circuit, have not had this blocking trouble.

If a new tube is used in most of the above cases temporary repair can generally be made without changing the resistor, but as soon as the tube begins to lose some of its output, the same trouble will re-occur long before the tube has lost all of its usefulness.

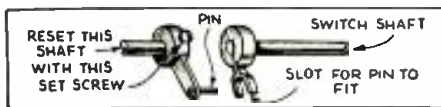

Fig. 1

. . . PHILCO

643 MODEL

This battery radio seems to lose its "pep" with age. I have found by removing the bypass cond. to the plate of the R.F. tube (No. 14 part in the schematics, 110 mmf. value) that the volume bounds forth with twice the "wallop." I don't know why it was put in the sets because it does not seem to affect the stability nor the tone quality on any band.

I have made this omission in more than 25 sets and many of the set owners have returned to tell me that their sets were far more powerful and selective than they were when new. I always align the sets after this operation, but I don't know as it would be necessary.

. . . PHILCO 38-A MODEL

There are still many of these battery radios still in existence, using the 15 tube



NOVEL PUBLIC ADDRESS INSTALLATION

During the Holiday Season it has been the policy of Colorado Springs for the past 3 years to install at the 4 leading intersections on the main street huge wooden frame-work bells standing 6 feet high with a diameter of about 4 feet at the base, which are covered with evergreen and then lighted. In each one of these bells a large loudspeaker is installed and all of them are operated from a central point and during the entire holiday season regular afternoon and evening Christmas music concerts are broadcast and heard over the entire business district.

Last season the Chamber of Commerce of Colorado Springs bought five 15-watt Wright-DeCoster speakers and placed them permanently in the bells. The 5th bell was used at a point about 3 miles from the city in another business section and was operated from its own amplifier and phonograph. The quality of the bells was much improved with the addition of the new permanent-magnet speakers and we had a good many compliments about them, both from local people and from Holiday visitors. The illustration above shows the bells at night, all lit up.

as 1st-detector and oscillator. The sets using these tubes often block badly and are inoperative; or at least on one end of the dial. This is due to the changing characteristics of the osc. coil, with age. I have found that, instead of changing the coil,

(Continued on page 699)

SERVICING QUESTIONS & ANSWERS

I.F. DOESN'T COME THROUGH

(126) James Gilfillan, Bethany, Mo.

(Q.) Gentlemen: The I.F. of a "home rolled" super., which I have to repair, is supposed to be 175 kc., but, in attempting to line up the I.F. transformers, I was unable to get an oscillator signal of this frequency through (although the transformers were tuned by means of the 6E5 "eye" tube) to make the set work very satisfactorily. I tried the full ranges of two signal generators, and tried varying the I.F. trimmer, but with no success. I tried connecting to both the I.F. grid, and to the converter grid. Two Servicemen who tried to help me were stumped.

The circuit involves a 6D6 R.F., 6A8G converter, 6K7G I.F., 6H6G 2nd-detector and A.V.C. in push-push, 6C5G audio amp., and a 41 output.

I recently replaced the aerial, R.F. and oscillator coils with high-quality coils, and put in iron-core I.F.'s, the first having a tap for v.s. This brought a notable improvement in performance, but did not materially change the peculiar oscillator pad value, which I determined by experimentation. The manufacturer of the oscillator coil calls for a 0.001-mf. pad. The value which works best in the set is about 750 mmf.

Recently I replaced the tuning condenser with a new Meissner condenser. This appeared to bring a better distribution of the band on the dial, but nothing else.

The "B" voltage is supplied by a 135 V., 30 ma. genemotor (which I just found to be delivering only 110 V., probably due to wear).

This set works very well, bringing in plenty of distance and lapping the 6E5 on almost every broadcast channel at night.

The "variable selectivity" control however does not have the broadening effect that it should.

The only spurious responses are a few interstation whistles. There are no repeat points, so far as I can determine.

(A.) In aligning the I.F. stages of a superheterodyne receiver, a modulated signal generator or oscillator is usually employed. Since you state that receiver operation is satisfactory, it may be assumed that the I.F. transformers were previously peaked to the correct frequency, or are closely tuned to 175 kc., or very little signal energy could be passed. For this reason, we believe the test oscillator was improperly connected to the receiver, without modulation, or the generator did not supply sufficient voltage for the purpose. Try beating the signal generator against the carrier of a strong local station to determine the condition of your test oscillator.

ERRATIC PERFORMANCE OF SKYRIDER

(127) Leslie C. Bureman, Buckner, Mo.

(Q.) I have for repair a 1935 Model S-5 Super-Skyrider giving me the following trouble.

1. A frying noise that gradually mounts in volume and then suddenly stops with a "crack." This occurs on all 5 bands. It can be cut short by snapping the B.F.O. switch.

2. Number 4 band (covers 1,200 kc. to 3,000 kc.) howls when the volume is turned about one-third up.

3. A loud cracking noise between 15 mc. and 16 mc. on No. 1 band when the volume is turned up about two-thirds.

4. Troubles 2 and 3 stop when the volume

is turned on full but return when the volume is retarded to position mentioned.

(A.) The symptoms described with regard to trouble in a Super-Skyrider receiver model S-5, point to a defective primary of one of the I.F. transformers, and a defective volume control. A check of the I.F. transformer primary windings may be made with a voltmeter of suitable range (sensitivity 1,000 ohms/volt) shunted across each primary, in turn. Fluctuation of meter during operation indicates the faulty transformer, which should be replaced.

Replace the volume control.

MOTORBOATING

(128) Walter Shire, Rochester, N. Y.

(Q.) I have a 12YI Motorola 1938 push-button tuner, motor-driven, with A.F.C. control. The complaint on this set has been a motorboating, starting at the high-frequency end of the dial. I have heard this in the customer's home; the procedure is as follows:

Tune in Station WHEC, 1,430 kc., either manually or by motor and A.F.C. The set will play normally for about 5 minutes, then it will start to bump-bump-bump; the eye tube follows this by opening and closing the width of the shadow. After an hour or so of operation the bumping will come in on any frequency on the dial. By placing a hand over the 6K7G I.F. tube or over the 6B8G tube it stops; also inserting a screwdriver under the chassis and twisting, will stop it for awhile.

I have had this set on the bench, have changed tubes, filter condensers, grid by-

(Continued on page 697)

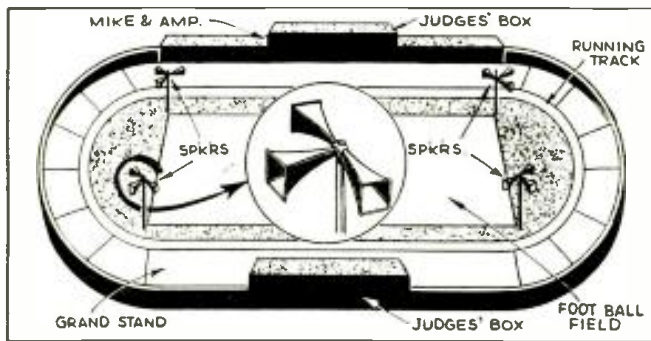

Actual speaker placement at an outdoor football field.

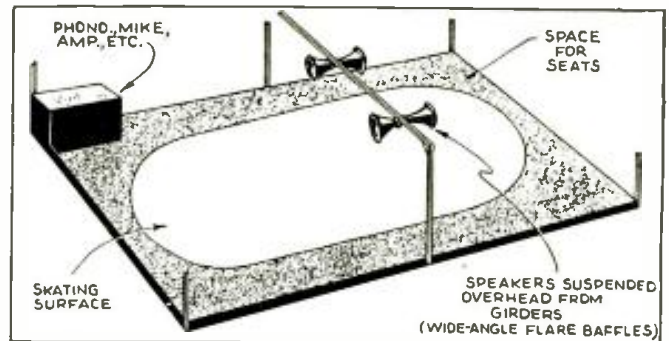

Location of loudspeakers in an indoor skating rink in Brooklyn (N. Y.).

SPEAKER PLACEMENT IN

Actual arrangements which helped overcome problems in the installation and specialists will welcome this meaty, up-to-the-minute article; it's "different"

HARRY

It might almost be said that the most important single consideration in planning a Public Address installation is the proper placement of the loudspeakers.

This would not be strictly true for the reason that, like the proverbial chain, the weakest link determines the total effectiveness. However, the fact remains that well-planned placement and "aiming" of the speakers, and selection of the best types for any given purpose, will result in maximum effectiveness, lower cost, or both. On the other hand, improper attention to these details will produce a less flexible and generally less satisfactory installation, probably with higher operating level, quality shot by reverberation, echo, or "hang-over", and with certain spots dead and others with enough volume of sound to "knock your ear off".

IMPORTANT "VARIABLES"

It might also be said, and this with considerable truth, that every sound installation is "a problem unto itself". It would seem, for instance, that installations in schools and auditoriums would be pretty much alike except for differences in the areas to be covered. Yet differences in input requirements, wall materials, room shape, room height, stage hangings, or the presence of a balcony, may all influence the selection and arrangement of the speakers. With such variations possible in installations for the same type of service, it is obvious that other types of service introduce their special problems and still further variations.

It is not always possible to plan the final speaker arrangement on paper, but this is certainly an excellent way to start. The experienced sound man can, by looking over the area and studying its blueprints or sketches, often plan his loudspeaker requirements with con-

siderable confidence before a piece of equipment is moved onto the premises. Even then, he will want to make operating tests and possibly make some alterations before he considers the job finished.

PLACEMENT TESTER

For the less expert installation man (and experts do it too), an excellent plan is to work on the basis of actual cut-and-try methods, using a portable sound system for the purpose.

This may seem a little complicated but it is an interesting fact that in New York City recently, when 3 of the best-known installation concerns were requested to bid on a school auditorium installation, each one of the 3 turned up with a portable system to determine the requirements and the equipment that would be needed to do the job properly! Then and only then were they in a position to submit bids which would do justice both to themselves and to the school.

ACOUSTIC FEEDBACK

To demonstrate that the best laid plans are not always fool-proof, a story is told of a recent and rather elaborate installation. After the installation was completed it was thoroughly checked and everything was fine. But when the audience assembled for the dedication of the new hall, trouble started in the form of acoustic feedback which made the system all but useless.

The installation men racked their brains and finally

discovered that the "boiled shirts" of the first nighters in the front rows were reflecting sound back to the stage and thus to the microphones. By slight changes which reduced the sound level in the front rows (where high level was not needed anyway), the trouble was cured.

GENERAL RULES

There are certain general rules which apply to substantially all installations. One of them is to keep the direct sound off large, flat wall surfaces which might produce echo effects and accentuate reverberation. Usually this can be accomplished by aiming the loudspeakers down into the audience, about three-quarters of the way back. Where there is a balcony this will mean two sets of speakers, one set aimed to the balcony, the other to the orchestra. A single set placed to cover both levels would leave the rear of the orchestra in the "shadow" of the balcony, or if the balcony is very shallow, would hit the rear wall beneath the balcony, with echo resulting. Even the front surface of the balcony may require covering with sound-deadening material to keep it from throwing the sound back to the

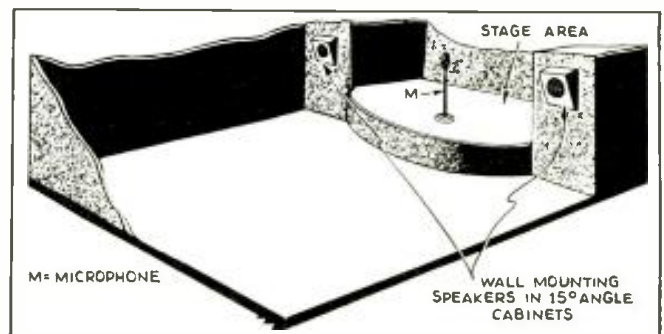

Effective location of loudspeakers in a theatre or auditorium which does not include a balcony.

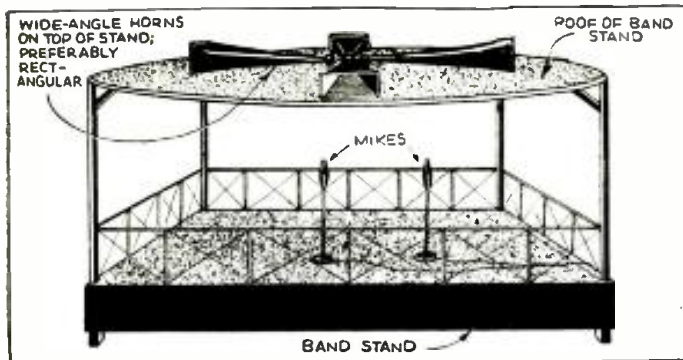

Fig. 4. A typical park bandstand's arrangement of speakers is shown above.

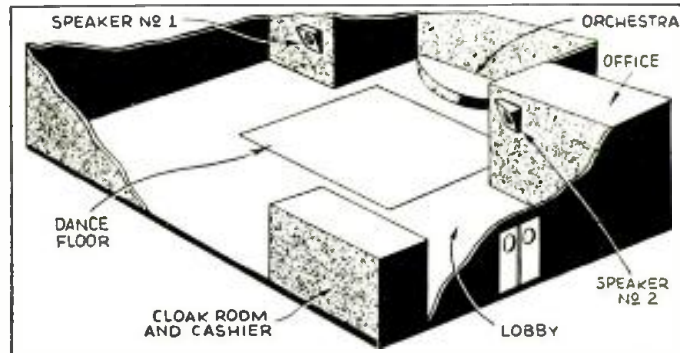

Fig. 5. Two wall-type speakers project sound beyond the dance floor of a New York restaurant.

PUBLIC ADDRESS WORK

operation of modern P.A. equipment are described by Mr. Paro. Sound from previous articles on this general subject printed in RADIO-CRAFT.

PARO

stage.

Another logical rule for auditoriums is to place the speakers well above the audience and reasonably close to the stage or other source of sound. The result is more natural to the audience as the sound will seem to be coming naturally from the source. Also, if the speakers are aimed about three-quarters way back there will be more nearly natural diminution of sound toward the rear of the audience.

Where microphones are to be used at various points, both on and off the stage, the use of horns or other directional baffles for the loudspeakers, and of directional microphones, will help to avoid feedback and still permit the loudspeakers to be placed well forward for natural sound effects.

In the case of restaurant orchestras, sound reinforcement is usually required only back in remote corners or in irregularly-shaped portions of the room. This is usually best obtained by the use of local speakers, operating at very low level. The music would normally come to such locations largely by reflection anyway so speakers placed nearby on the wall provide a normal effect.

There have been numerous formulas

and tables prepared for use in calculating the power requirements for sound reinforcement installations but at best, these are only very rough approximations and are subject to so many variation factors that they are only of the most limited use. Experience, or cut-and-try methods are the best guides in this matter; always allowing ample reserve power in both amplifier and speakers to provide more than ample coverage under the most severe conditions of local noise, etc.

Frequency response of the equipment is highly important. For speech reproduction an abundance of "lows" is to be avoided, but these are needed for reproduction of music. The correct amount of "highs" for either music or speech will vary widely at different times. With the high frequencies adjusted for normal balance when a hall is empty, the presence of a crowd may attenuate them to a point where they are scarcely perceptible, due to the more pronounced absorption effect of clothing at these frequencies. The general volume requirements will likewise vary with the size of the crowd, not only because of this absorption but because the noise level rises in proportion to the number of people.

The speakers selected should, therefore, be capable of reproducing the maximum frequency range desired, leaving it to the amplifier adjustments to narrow this range when occasion and conditions demand.

To illustrate the solutions of some speaker selection and placement

problems, the accompanying sketches represent several actual installations; some of them typical (if there is any such thing in the public address field) and others less usual.

STADIUM

Figure 1 illustrates an outdoor stadium installation in South America. An athletic and football field is enclosed within an uncovered bowl, 700 feet long by 500 wide, which accommodates some 40,000 spectators. The specifications called for the use of microphones on the field itself and in an enclosed judges' box at the rear of the stand. Clustering the speakers in the center of the field was impossible. In the first place, the use of the field for football ruled out poles or overhead supporting cables. Secondly, such an arrangement would not permit the free use of microphones on the field, without feedback trouble. Nor was it practical to mount speakers around the edge of the stands because, due to its great circumference but shallow depth, a tremendous number of speakers would have been required.

A solution which overcame all problems is shown in Figure 1. A total of 12 speakers with cylindrical horn baffles was used and all operated at much lower level than would have been necessary were they placed in the center of the field. Directing all sound away from the field, announcers could follow play right from the field without danger of feedback. The speakers were elevated to a point opposite mid-height on the grandstand thus providing substantially equal sound volume with some falling off, but still ample, in the top-most rows.

A 100-watt amplifier proved capable of overcoming the high noise level. To avoid any possible interruptions an identical amplifier was held in reserve
(Continued on page 692)

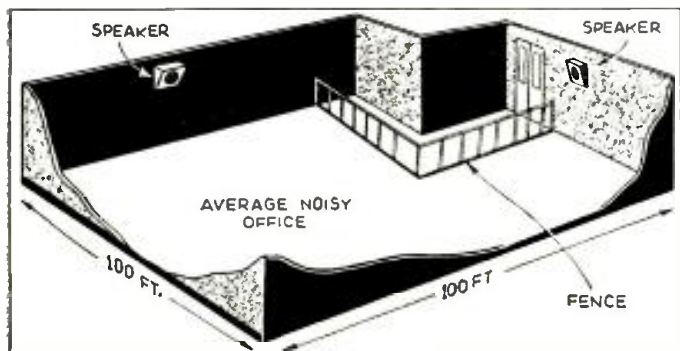

Fig. 6. A call system speaker placement problem was solved as shown above.

THE LATEST RADIO EQUIPMENT

The address of any mentioned manufacturer will be sent on receipt of a self-addressed, stamped envelope. Mention of item number hastens reply.



Sight and sound television set. (1743)

SIGHT AND SOUND TELEVISION SET (1743)

(Andrea Radio Corp.)

SIXTEEN TUBES are used in this newly-marketed "duolateral" super-heterodyne which employs 2 intermediate frequencies, one for video and one for audio. Illustrated is the table model 1-F-5 which uses the special 5-in. *short-neck* cathode-ray tube, making possible a depth of cabinet not much greater than a standard, table-type broadcast set.

The standard set model covers 2 sight and sound channels, 44 to 50 and 50 to 56 megacycles, although other frequencies can be used by merely changing the tuning unit. This model features "sharp focus" image reception, and "picture tone" sound (which is claimed to be distinctly different from the tone of broadcast reception).

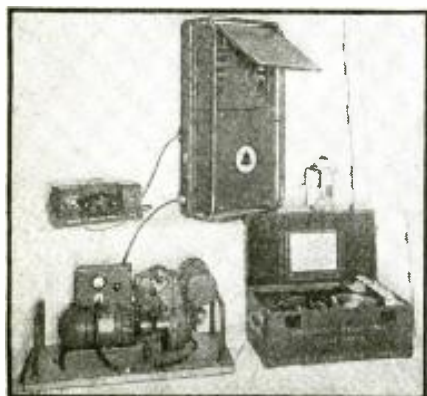

Emergency radio telephone equipment. (1744)

EMERGENCY RADIO TELEPHONE EQUIPMENT (1744)

(Bell Telephone Labs.)

THIS portable, combined radio sending and receiving equipment, was designed for the sole purpose of handling emergency situations where telephone wires cannot readily be employed. The hurricane and flood damage to communication systems in New England last September demonstrated the need for such apparatus—which of course may be used for *any* extra service. Illustrated are the radio transmitter and receiver, the operator's control and switching unit, and a rod antenna.

Lacking commercial power, a small, 600-watt gasoline-driven generator (part of the equipment) may be used. Minimum range is about 25 miles; under favorable conditions, considerably more.



Latest portable battery set. (1745)

LATEST PORTABLE BATTERY SET (1745)

(Stewart-Warner Corp.)

COMPACT and streamlined in appearance this latest portable affords instantaneous reception almost anywhere and, it is claimed, under any conditions. The "Companion" is a self-powered super-heterodyne portable battery set with built-in antenna, requiring no hooking up or plugging in to operate. Four tubes of the new low-drain type are used; selectivity, gain and tone quality are said to be excellent. Waterproof case measures 7 $\frac{7}{8}$ ins. high x 13 ins. wide x 7 $\frac{1}{2}$ ins. deep.

NEW PORTABLE "TUBEMASTER" (1746)

(John Meck Instruments)

KNOWN as the Pattern 20-A Tubemaster, this new instrument employs what the manufacturer calls the "3-in-1 test" in that mutual conductance, power output, and emission quality are all indicated in a single test. Both the "Good-Bad" direct-reading meter scale and the control panel are made of translucent dialophane, and are illuminated from below. It will test all tubes, including those with 35-V. filaments and the loktal-base types. Housed in leatherette-covered carrying case with removable cover.

30-WATT SOUND SYSTEM FOR TRAVELING CHURCH (1747)

(Wholesale Radio Service Co., Inc.)

A NOVEL but practical public-address installation was recently made by the Lafayette Radio Corp., division of Wholesale Radio Service Co., Inc., in a missionary trailer of the Diocesan Missionary Fathers of Richmond, Va.



New portable "Tubemaster." (1746)



30-W. sound system for traveling church. Left, the trailer chapel; and right, the sound equipment. (1747)



The trailer, in addition to incorporating a completely-equipped chapel, includes living accommodations for the 2 missionaries who accompanied it.

The sound system as shown in the illustrations includes a 30-W. amplifier, radio tuner, phonograph turntable and microphone, 2 loudspeakers and baffle horns (affording coverage of large areas), and a monitor speaker inside the trailer. A 1,500-W., 110-V. A.C. generator, driven by a 4-cylinder gas engine mounted in the rear of the car which pulls the trailer, supplies power not only for the equipment but also for lighting and cooking. A secondary 6-V. storage battery system supplies lighting when the car is detached from the trailer.

UNIVERSAL SUPERTESTER (1748)

(Radio City Products Co.)

THIS comprehensive yet inexpensive tester provides for accurate measurements in many ranges of not only radio and television equipment but general industrial equipment. Hence it finds its use not only with radio men but with electricians, mechanics, handymen, etc.

Some of its feature ranges are: 5,000 V. A.C. and D.C.; 25 amperes A.C. and D.C.; low ohmmeter range with center scale of only 5 ohms, each of the first 10 divisions measuring 0.1-ohm; high ohmmeter range of 4 megs. Besides these it has several other A.C.-D.C. voltage ranges, microampere ranges, milliampere ranges, decibel ranges and may be used as an output meter. *It is ideal for measurement of all refrigeration and appliance motors, lighting and power circuits and many other practical uses.*

NEW 18-W. AMPLIFIER (1749)

(The David Bogen Co., Inc.)

KNOwn as the model DX-18 this new amplifier features an electronic tone corrector which accurately corrects and makes allowances for varying room acoustics. It is a 10-tube job putting out 8 W. It provides for 2 high-gain and 2 low-gain input channels. Remote control is optional. The amplifier incorporates universal output for matching into various arrangements of speakers.

NEW AUTO ANTENNA (1750)

(The Radiart Corp.)

THIS new telescopic cowl-type auto-radio antenna, made of Admiralty metal and chromium-plated to guard against rust, mounts under the hood, thus eliminating the necessity of drill-

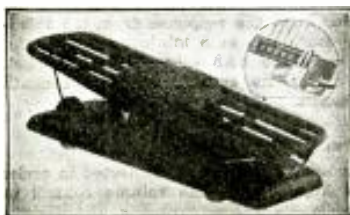

Footpedal volume control. (1755)

ing the finished body panel. The antenna not only looks attractive in the car but, it is claimed, its location appreciably increases signal pick-up. Its plastic insulators are modern in design.

SOCKETS AND ADAPTERS FOR LOKTAL TUBES (1751)

(American Phenolic Corp.)

TUBE TESTERS, analyzers and receivers can now be modernized to use the new loktal tubes by utilizing these latest loktal-type adapters and sockets. They are molded in black bakelite or a new tan color ultra-low-loss mica-filled bakelite. They are supplied with molded-in, plate retainer ring mounting or an adapter plate for replacement work. Contacts have a long wiping action and grip the entire length of the tube prong securely.

GLASS-SEALED ATTENUATORS (1752)

(Ohmite Manufacturing Co.)

LIKE the hermetically-sealed precision resistors recently described in this department, this new fixed attenuation pad is the first commercial unit to be hermetically sealed in a strong glass tube affording perfect protection against heat, humidity, salt air, and other severe atmospheric conditions prevalent in industrial, coastal, marine and tropical locations. The attenuator can be furnished to match the impedance of any line and given any desired decibel loss from 0.25- up to 40 decibels or infinity. It is built like a radio tube and provided with bakelite tube base for mounting in tube type sockets. The units are made to order to fit particular requirements and are available as "H," "T," "Pie" or "L" pads.

CHAIR-SIDE RADIO SET (1753)

(RCA Manufacturing Co.)

SEMI-CIRCULAR in shape, with the flat side fitting against the chair, this new receiver presents an unusually smart appearance. The instrument is 22 ins. high x 24½ ins. wide x 13½ ins. deep. Fully one-third of the rounded outside portion of the cabinet is given over to the loudspeaker grille which extends from the top to the base rail. Features of the 6-tube, 3-band chassis include electric tuning, A.V.C., continuously-variable tone control, victrola pushbutton and plug-in switch for phonograph attachment. Its tuning range covers domestic and foreign broadcasts as well as police, aviation and amateur calls.

(Continued on page 702)



Automatic radio blowtorch. (1754)

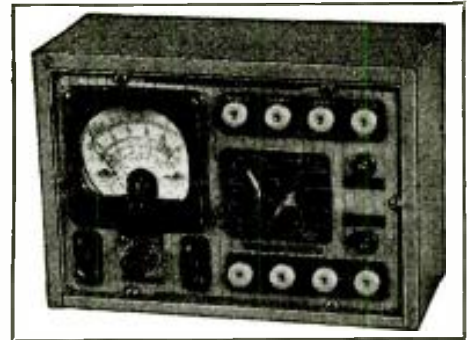

Universal supertester. (1748)

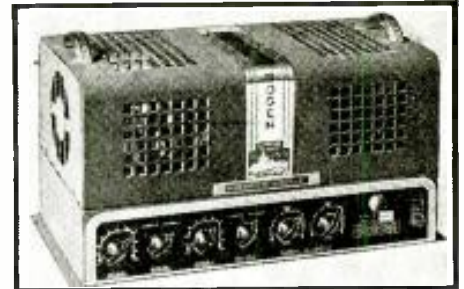

New 18-W. amplifier. (1749)



Chair-side set. (1753)



Glass-sealed attenuators. (1752)



Loktal sockets (1751)



New auto antenna. (1750)

EMERSON MODELS AX-211, AX-212, AX-217, AX-235, AX-237, AX-238, AX-239, AX-240 (Chassis Model AX)
 5-Tube A.C.-D.C. Superheterodyne; Automatic Volume Control; Broadcast Band (Range 540 to 1,730 kc.); Power Consumption 45 watts;
 Beam-Power Output; "Miracle Tone Chamber"; Built-in Antenna.

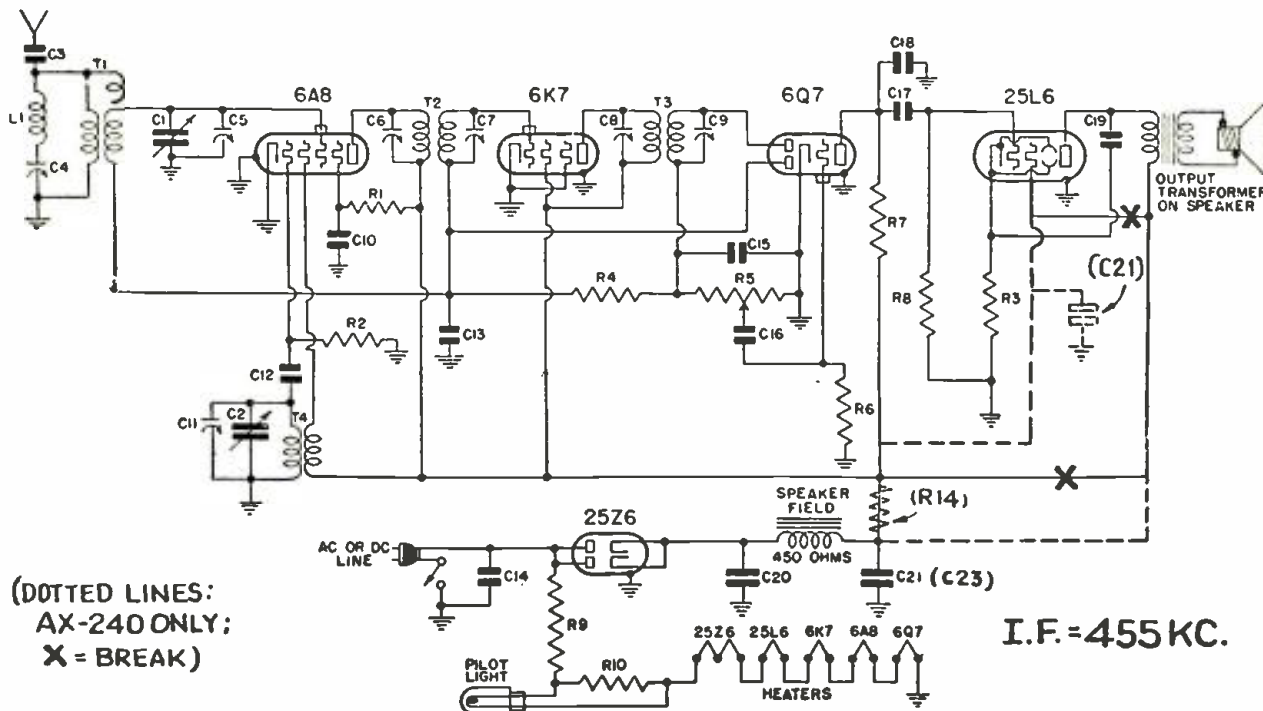

(DOTTED LINES:
 AX-240 ONLY;
 X = BREAK)

I.F. = 455 KC.

RESISTORS

- R1—30,000 ohms, 1/4-W.
- R2—50,000 ohms, 1/4-W.
- R3—140 ohms, 1/2-W.
- R4—1 meg., 1/4-W.
- R5—volume control, 0.25-meg.

- R6—15 meg., 1/4-W.
- R7—0.25-meg., 1/4-W.
- R8—0.5-meg., 1/4-W.
- R9—150 ohms
- R10—40 ohms
- R14—(AX-240 only) 2,500 ohms, 1 W.

CONDENSERS

- C1, C2—2-gang tuning condenser
- C3—550 mmf.

- C4, C5, C6, C7, C8, C9, C11—trimmers
- C10—0.05-mf., 200 V.
- C12—60 mmf.
- C13—0.1-mf., 200 V.
- C14—0.1-mf., 400 V.
- C15, C18—220 mmf.

- C16—0.002-mf., 600 V.
- C17—0.02-mf., 400 V.
- C19—0.025-mf., 400 V.
- C20, C21—(*AX-240 only) 20 mf., 150 V.
- C23—(AX-240 only) 20 mf., 125 V.

VOLTAGE ANALYSIS

Readings should be taken with a 1,000 ohms/volt meter. Voltages listed below are from point indicated to ground (chassis) with the volume control turned on full and no signal. Line voltage for these readings was 117.5 volts, 60 cycles, A.C. All readings except heaters and cathodes were taken on 250-volt scale. Measurements made with 117.5 volts D.C. will be lower than those given below.

Tube	Plate	Screen	Cathode	Osc. Plate	Fil.
6A8	100	55	0	100	6.3
6K7	100	100	0	—	6.3
6Q7	43	—	0	—	6.3
25L6	92	100	5.5	—	25.0

Voltage at 25Z6 cathode—128 volts. Voltage across speaker field—28 volts.

ALIGNMENT

An oscillator with frequencies of 455 and 1,400 kc. is required. An output meter should be used across the voice coil or output transformer for observing maximum response. Always use as weak a test signal as possible when aligning the receiver.

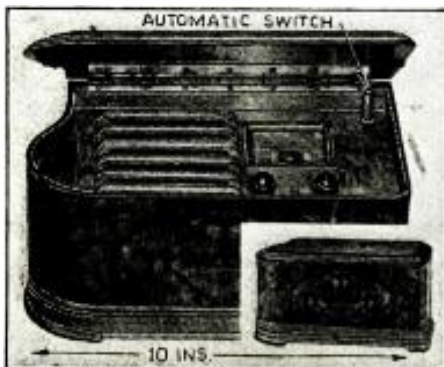

Emerson Model AX-238. Notice the automatic line switch. Closing the lid shuts the set off.

The 455 kc. wavetraps is mounted on the same form as the antenna coil directly behind the speaker. The trimmer for the 455 kc. wavetraps is mounted on the coil and is accessible from the rear of the chassis. The oscillator coil is located underneath the chassis, beneath the 1st I.F. transformer.

I.F. and Wavetraps Alignment

Swing the variable condenser to the maximum capacity position. Feed 455 kc. to the grid-cap of the 6A8 tube through a 0.01-mf. condenser and adjust the 4 I.F. trimmers for maximum response. Feed 455 kc. through a 100 mmf. condenser to the antenna lead and adjust the wavetraps for minimum response. (See General Notes, paragraph No. 6.)

R.F. Alignment

Set the dial pointer at 140. Feed 1,400 kc. through a 100 mmf. condenser to the an-

Location of Coils and Trimmer Adjustments

The 1st I.F. transformer is mounted on top of the chassis deck beside the speaker. The trimmers are accessible through holes in the top of the can.

The 2nd I.F. transformer is mounted underneath the chassis beneath the variable condenser. The trimmers are accessible through holes in the top of the chassis directly beneath the variable condenser.

The trimmers for the antenna and oscillator coils are located on the variable condenser. The trimmer on the front section is for the antenna coil.

The 455 kc. wavetraps is mounted on the same form as the antenna coil directly behind the speaker. The trimmer for the 455 kc. wavetraps is mounted on the coil and is accessible from the rear of the chassis. The oscillator coil is located underneath the chassis, beneath the 1st I.F. transformer.

tenna lead and adjust first the oscillator trimmer (on rear section of variable condenser), then the antenna trimmer (on front section of variable condenser) for maximum response.

GENERAL NOTES

1. If replacements are made or the wiring disturbed in the R.F. section of the circuit, the receiver should be carefully realigned.
2. One side of the power line is directly grounded to the chassis base. Under no circumstances, therefore, should a ground wire be permitted to come in contact with any metal part of the receiver.
3. The filament dropping resistor (R9—see schematic) is a resistance wire in the special line cord. The cord will, therefore, become warm under normal operating conditions. To insure good heat radiation stretch out the line cord to its full length. Do not attempt to shorten it by cutting.
4. In operating the receiver on D.C. it may be necessary to reverse the line plug for correct polarity.
5. The color coding of the I.F. transformer leads is as follows:
 Grid—green Plate—blue
 Grid return—black B plus—red
6. The wavetraps in the receiver has been adjusted for maximum signal rejection at 455 kc. If, however, persistent interference is experienced from some particular telegraphic station, readjust the wavetraps trimmer until the response from the interfering station is at a minimum.
7. To remove the 6A8 tube from its socket, push up on its center pin from beneath the chassis.

Production Change

A 100,000-ohm resistor is connected in series with the high side of the volume control in later models.

INTERNATIONAL KADETTE A.C.-D.C. MODEL KRC-2 "TUNEMASTER"

4-Tube Superhet. Unit; Output Signal 1,570 kc.; Tunes and Controls Volume of Any Remote Receiver; Operates on 110 to 125 V., A.C. or D.C.; No Connections to Remote Receiver; Pushbutton Tuning for 4 Stations; Tunes Other Stations Manually.

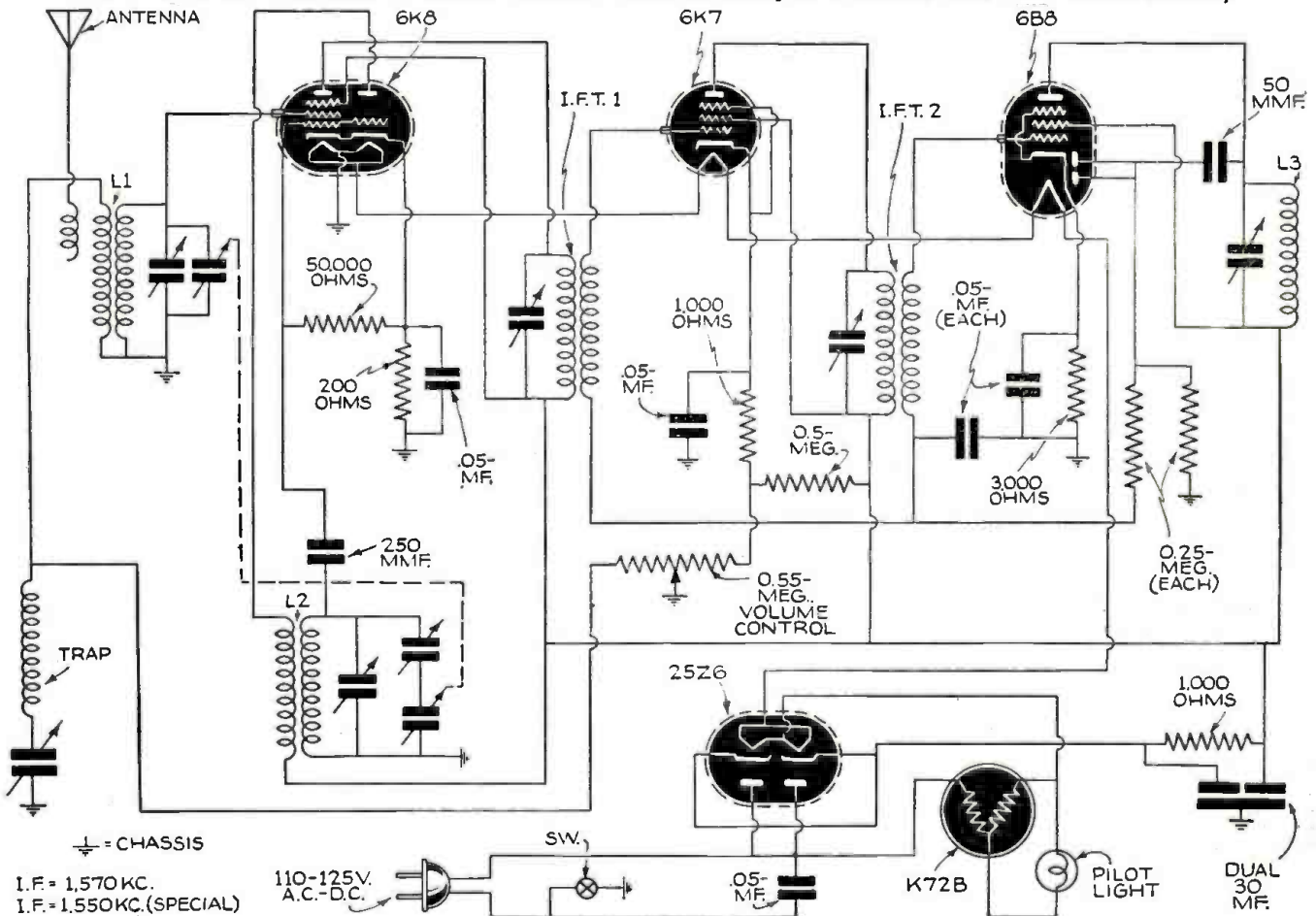

Schematic diagram of the Kadette KRC-2 Tunemaster. The last coil on the right is the signal radiator.

This chassis is designed to operate from 110-125 volt power lines, either alternating or direct current. Note that one side of the line is grounded to the chassis; an external ground is neither needed nor used.

The following tubes are employed:

- 6K8 1st-Detector-Oscillator
- 6K7 I.F. Amplifier
- 6B8 Output
- 25Z6 Rectifier
- K72B Regulator

ALIGNMENT

To align the KRC-2 Tunemaster it will be necessary to set up a standard broadcast receiver accurately tuned to 1,570 kc. with a signal generator. Use a standard output meter connected to the output of the receiver. The Tunemaster should then be set up close to the broadcast receiver as explained in the instruction sheet so that its signal will be picked up strongly by the broadcast receiver. The signal pick-up antenna parallels the power cord for the full length of the latter; and then is extended (unreel) as much further as necessary for maximum signal pick-up with minimum noise pick-up.

I.F. TRIMMERS: Feed 1,570 kc. modulated signal from signal generator directly to antenna of Tunemaster. Adjust both I.F. trimmers to maximum reading on output meter. Then adjust output coil trimmer to maximum.

Note that output coil is directional; turn Tunemaster until best direction is obtained, if receiving set is some distance from Tunemaster.

R.F. TRIMMERS: Set Tunemaster dial at 1,500 kc. and feed 1,500 kc. signal from signal generator to antenna of Tunemaster. Set antenna trimmer approximately 1/4-turn from tight. Peak oscillator trimmer at 1,500 kc. Set dial at 600 kc. and peak series oscillator trimmer. Move dial and series trimmer simultaneously by small amounts so as to get maximum output at 600 kc. Tune back to 1,500 kc. and peak oscillator trimmer. Repeat previous peaking of series trimmer at 600 kc. Retune to 1,500 kc. and peak oscillator trimmer. Set dial at approximately 1,400 kc. Tune signal generator to resonance with Tunemaster. Then peak antenna trimmer.

(Be sure to hold the tuning mechanism rigidly once a station has been accurately tuned-in by means of a pushbutton, while tightening the white lock-knob in the center of the manual-tuning knob.)

Note that the Tunemaster may be used to obtain additional selectivity and sensitivity from existing receivers where the original receiver is of such design that no amount of service work will bring the sensitivity and selectivity to quite sufficient levels. The added sensitivity and selectivity are the result of the over-all performance of the 6K8, 6K7, and 6B8 tubes.

AVERAGE SOCKET VOLTAGES

Tube	Position	Cathode Voltage	Osc.-Plate Voltage	Screen-Grid Voltage	Dct.-1 Plate Voltage
6K8	Det.-Osc.	2.5	110	110	110
6K7	I.F.	6.5	—	110	110
6B8	Output	10	—	100	115
25Z6	Rectifier	100	—	—	—

Line 118 volts. Volume control full on. 10% variation allowable. Measurements made from tube prongs to circuit ground, with 1000 ohms/volt meter.

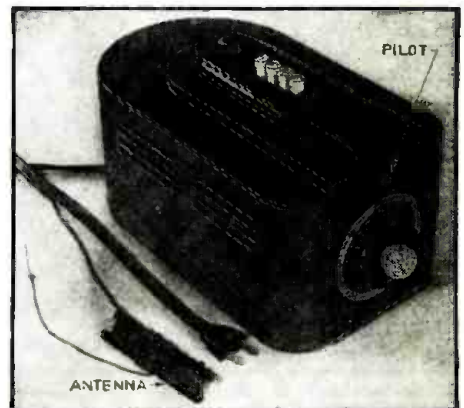

Kadette Model KRC-2 Tunemaster. Four stations can be tuned automatically with pushbuttons, others manually.

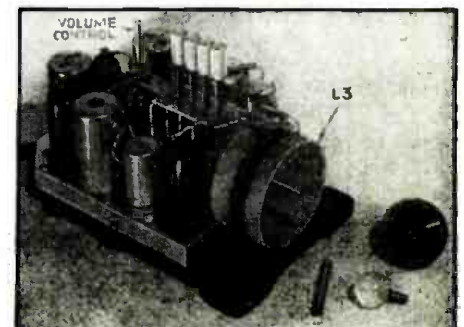

Interior view of the Tunemaster. The large coil (L3) in front is the signal radiator.

A Modern Rod Antenna

The old-style "wire" antenna may soon be superseded, for home-radio broadcast and shortwave reception and amateur-radio transmission and reception, by the "rod" antenna. Mr. Jacob describes the many advantages of the newer type of antenna.

CHARLES F. JACOB

THE new "Verti-Flex" or flexible vertical antenna, here described, is ideal for broadcast and shortwave reception, and for amateur radio transmission. There are no guy wires, as the antenna is self-supporting. The base area required is, of course, very small. The antenna can be mounted on a flat (horizontal) surface, or on a wall (vertical surface). A bracket is available, so that the antenna, when mounted on a wall or chimney, does not sway and hit the wall.

A case-hardened aluminum alloy is used for lightness and strength. The antenna has a patented damping feature which prevents it from oscillating at its own vibration period—which if unchecked ultimately results in failure. Damping and re-enforcing is accomplished by inserting hardwood dowels in the tubing. As a result the verti-flex sways freely and does not oscillate. Under test, the verti-flex has withstood one of the strongest winds experienced in the Chicago area—showing no signs of weakness.

In addition to strengthening the antenna under heavy wind pressure, the dowels prevent the metal tubing from flattening or buckling. Figure A shows the behavior of the 20-meter antenna in a wind with a measured velocity of 45 miles-per-hour. Note the perfect streamlining and the absence of sharp bends. The picture was taken atop an 8-story building, in a wind that brought down many amateur "sky wires."

The camera was located to show the maximum curvature. There was no tendency to oscillate or vibrate. The 10-meter verti-flex showed no apparent curvature during similar tests.

MECHANICAL FEATURES

The tapered 4-inch telescopic joints are ground to 0.005-inch. Such a close fit excludes air from the joints, thus preventing corrosion and subsequent high-resistance contacts. Nor can water get into the joints, so close is the fit. This feature insures long life and excellent performance both for broadcast use and for transmitting purposes. Also, the tight fit contributes to the strength of the antenna, and eliminates play at the joints.

No screws or bolts are used because this method of joining the sections would only weaken the antenna. The verti-flex is assembled by fitting the tapered sections together, one joint at a time, beginning with the bottom tube. The bushing is tightened, and by dropping the poles vertically to a board

from a height of about 6 inches, the joint is further tightened to make good contact. The next section is fitted to the assembly, and the procedure repeated, till the whole antenna is assembled. Until the bushing is intentionally loosened, the joint cannot be pulled apart.

PERFORMANCE

Because there are no guy wires, the radiation pattern of the verti-flex is circular. No power is absorbed in supporting wires, and so your transmitter radiates more efficiently.

For directive beam transmission and reception, two verti-flex antennas can be used, parallel and a full $\frac{1}{4}$ -wave apart; one is fed as usual, the other acting as a reflector.

When used for transmitting, the verti-flex can be fed efficiently from the common Zepp feeders. (See Fig. 1.) For long lines, the matched-impedance feeders are more useful. Two 17-foot sections mounted horizontally for directive transmission will give excellent results when fed by a 72-ohm line. (See Fig. 2.) More construction data for other types of transmission lines can be found in the various editions of the amateur's handbook.

INSTALLATION

A porcelain insulator, 4 ins. in diameter, and with an overlapping apron designed for minimum leakage (either antenna will handle 1 kilowatt on 10 meters), is held in compression by a malleable cast steel base. A lead collar around the insulator provides cushioning against irregularities in the casting. The insulator is held firmly and does not give under heavy wind pressure.

A special insulated supporting bracket is available for the 34-foot pole, for keeping the pole from swaying and scraping against the wall, when the verti-flex is mounted in that manner. This upper sidewall mounting can be attached to any point along the antenna, and does not interfere with its operation.

As a broadcast receiving antenna, the verti-flex can be used conventionally, or, with matching transformers, as a noise-reducing antenna. The upper or pole transformer is enclosed in porcelain, and has a built-in lightning arrester, approved by Underwriters' Laboratories. The transformer itself is a broadly-tuned iron-core type. It is connected as close as possible to the

(Continued on page 696)

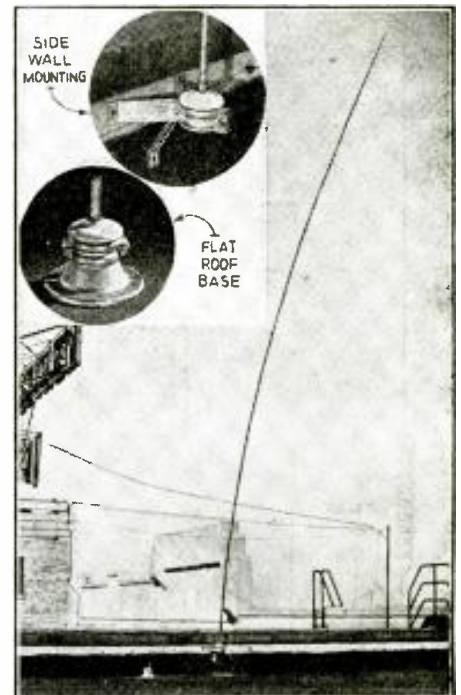

Fig. A. Photograph taken of the flexible rod antenna during a wind velocity of 45 miles per hour. Note the perfect streamlining and the absence of any sharp bends. Short lengths of wood dowels, placed in the hollow center of the rod, do the trick. The inset illustrates the two available methods for mounting the rod. The antenna illustrated is the 20-meter model.

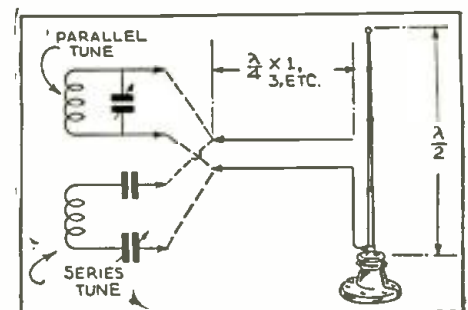

Fig. 1. The antenna can be used for transmitting; in which case it can be efficiently fed from common Zepp feeders. Either series or parallel tuning may be used depending upon the length of the feeders.

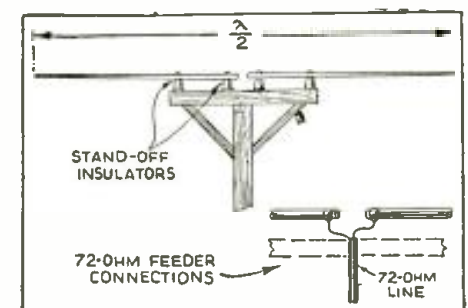

Fig. 2. Two 17-ft. sections, mounted horizontally, and fed by a 20-ohm line, afford 20-meter directive transmission. Instead of concentric cable feeders (shown), a twisted-pair could be used.

All the worthwhile
Radio Trade News
of the past Month—
Digested for busy
radio men.

RADIO Trade Digest

A PLEDGE: — To
print the important
news of the radio
industry; to review
major news events;
to help point a path
to radio profits.

IMPORTANT HAPPENINGS OF THE MONTH IN THE RADIO INDUSTRY

No. 9

MAY, 1939

No. 9

NATIONAL PROMOTION TO BOOST RADIO BIZ

*Radio Mfr.'s Ass'n. Pushes
"Buy RMA" Slogan to
Help Members*

Initiation of the national all-radio promotion project of RMA and the National Association of Broadcasters was approved by the RMA Board of Directors at its meeting in New York on February 2. RMA's board of governors also approved a new cooperative project with a National Research Council committee for promotion of radio equipment of schools nationally. Another RMA promotion project, for amplifier manufacturers, is also proceeding, and the Board of Directors took further action to promote the "Buy RMA" plan in the interest of parts and accessory mfrs.

The joint RMA-NAB campaign contemplates immediate organization of local "Radio Councils" in each state where NAB broadcasting stations are located and will include broadcasters, distributors and dealers, utility representatives, *Service*men, and public spirited citizens. A program will be prepared for the guidance of local radio organizations, with data and material for use by the local Councils.

Also planned are broadcast programs for both networks and local stations, with scripts and transcriptions sup-
(Continued on page 703)

Reservations Going Up for Chicago Parts Show

Reservations for the National Radio Parts Show, in Chicago next June, are considerably ahead of last year. Few additional booths are now available. A program of interest to parts manufacturers, distributors, sales representatives, *Service*men and others is being arranged.

OLD MFR. IN NEW FIELD

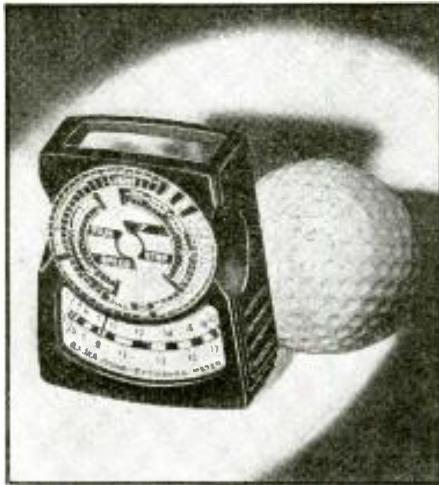

Still pioneering, DeJur-Amsco, radio pioneers, are entering foto field with swell exposure meter at \$10.50. Note size.

Freight Reduction Sought

Freight rate reductions and adjustments are being sought by the RMA Traffic Committee on receiving sets, including television, loudspeakers, and tubes, for local and carload lots.

RADIO MFRS. ENTERING OTHER ACTIVE FIELDS

*Two Leading Radio Firms
Introduce Non-Radio
Accessories*

Two of the best-known pioneer companies in the radio field have augmented their business by invading non-radio fields. These are DeJur-Amsco Corp., with a photographic exposure meter, and Ohmite Mfg. Co., with a special rheostat for remote control of model railroad trains.

The DeJur meter (shown at left) is a tiny, high-sensitivity instrument which indicates correct photographic technique for varying light conditions. It's a precision job, neat, convenient, and moderate in price. It should prove a ready seller.

The Ohmite control stops or reverses a model train, and gives control of its speed. Two models are provided, for
(Continued on page 703)

Carter Says It's So

"Messers. High & McNinch seem to differ in their accounts of your disappearance from the air waves. Will you kindly state the true reason or reasons—that is, please give an account of the events leading up to the tragedy," said RTD's representative to Boake Carter.

Carter replied that the facts, as re-
(Continued on page 703)

NEW HELPS TO MORE SALES BY LIVE MANUFACTURERS

OXFORD SPEAKERS
FOR BEST RESULTS

REPLACEMENT AND PUBLIC ADDRESS SPEAKERS

• Permanent Dynamic - Electro Dynamic - Magnetic
• 3 Inch to 16 Inch Speakers
• Improved Scientific Construction

ACCEPTED BY SOUND JUDGMENT

DEALER'S NAME

COMPLETE RADIO SERVICE

We Recommend
SYLVANIA RADIO TUBES

Left & Right—Jobber & consumer 6-color counter display cards to push Oxford speakers. Above—Hygrade Sylvania's illuminated 13½ x 20 in. electric clock sign is \$6 with imprint.

MAKE YOUR OLD RADIO SOUND LIKE NEW

OXFORD SPEAKERS

★ Amazingly Low Cost
★ Oxford Speaker For Every Size Set
★ Ask For Full Details

ACCEPTED BY SOUND JUDGMENT

JOINED



WALDON H. KUNZ, head of the Radio Engineering Dept. of Indiana Technical College, has joined the engineering staff of Supreme Instruments Corp., where he will do research & development work in the hi-freq. field. He's also an ex-Serviceman!

DIED



LEROY H. LINK, secy.-treasurer of the G-E Supply Corp. since its formation 10 yrs. ago, died early this year after a short illness. Mr. Link was only 56 years old.

ADVANCED



C. J. BURNSIDE, former mgr. of radio engineering for Westinghouse, has been advanced to mgr. of radio sales of the same co. C. J. did design work on America's most powerful station, WLW, & on IRO, Rome, Italy. He was born in Des Moines, Ia., in 1901.

The RSA Monthly Bugle

(News of the Radio Servicemen's Assn.)

NEW CHAPTERS

Fort Wayne, Indiana, and St. Joseph, Missouri, have joined RSA. Officers of the Fort Wayne Chapter are: Henry A. Schryver, Chairman; and E. Moennig, Secretary and Treasurer.

The Radio Servicemen's Association of St. Joseph is under the direction of Cleo Blodgett, Chairman; E. R. Sullwold, Secretary; and Russell Goerhe, Treasurer.

The basis for a Chapter in Toledo, Ohio, was laid at a meeting of 200 Servicemen, sponsored by Owen Smith of the Warren Radio Co., a Toledo jobber. A committee was appointed to carry out the details of the formation of the Chapter. All of the local jobbers pledged their cooperation and support.

Servicemen of Pekin, Illinois, are taking the necessary steps to form a chapter in that city, and official affiliation may be expected soon.

Alton, Illinois, Chapter held 3rd annual election. The officers of the Chapter now are: Robert Clayton, President; Elmer Kemmery, Vice-President; and Robert Foster, Secretary-Treasurer.

Any member late at a regular meeting is to be fined 10c; and if he does not show up at all, a quarter! Exceptions are cases where the member can't help it.

Binghamton, N. Y., Chapter officers of last year were reelected for 1939.

Chicago Chapter has approved publication of a local house organ. The first issue was released January 19th.

Decatur, Illinois, Chapter: The annual election of officers resulted as follows: Herman Tille, President; Arthur Shuler, Vice-President; Maurice Alexander, Secretary; and Raymond Shaw, Treasurer; Clyde Songer was elected Educational Director; Lester Dunscombe, Membership; and Dewey L. Otta, Publicity. Homer Kirchoff was appointed Sergeant-at-Arms. Several new members have been enrolled.

Detroit Chapter held its election January 16th. Only the qualified member has the right to hold

(Continued on page 703)

6 RCA EXECUTIVES WIN MAJOR PROMOTIONS



DAVID J. FINN, Asst. Adv. Mgr., since 1934, has been made Adv. & Sales Promotion Mgr. He's from Natick, Mass., & has been in radio & electricity since '23. Later became Tom Joyce's asst. Eyes right!



JAY D. COOK heads the new International Div. after 12 yrs. in accounting, export & other depts. Was treas. of RCA-Victor in '32, but gave it up to supervise the co.'s foreign subsidiaries.



EDWARD W. BUTLER now manages Radio & Victrola div. Was engineer on Cunningham tubes in '24, but transferred to Radio-tion when co. commenced. Became sales mgr. in '35, & took on phonos in '37.



PAUL C. RICHARDSON, with the co. since only '36, now Educational Sales Div. Mgr. Earliest work was in educational field; then with Sat. Eve. Post. in radio with Pierce-Phelps, Phila. distrib.



THOMAS F. JOYCE, at 34, is RCA's youngest v.p. He was calibrating meters in a factory in '22. Took a night school course; now he's Adv. Director. He's the man who devised the Record Society.



FRANK B. WALKER is other new v.p. in charge of Record Activities. Has been in record biz since '19; was gen. mgr. of Columbia Phono in '24; joined RCA in '33 to organize transcription dept.

Oldest Victrola Contest

Winners Awarded Prizes

The 20 owners of the oldest Victrolas made during the years 1906-1925 to receive cash prizes of \$250 each as winners of the Oldest Victrola Contest sponsored by RCA Victor, have been announced. More than 55,000 entries were received.

Each winner receives his prize through the RCA Victor dealer from whom he received his entry, the presentation being made in the dealer's store. In addition, each of the 20 dealers who actively promoted the contest receives a prize of \$250 worth of RCA Victor merchandise.

A board of judges compared the serial and model numbers submitted by entrants with the old production records.

The phonos are to be turned over to the dealers, who will use them as the basis for outstanding window displays. They will then be shipped to Camden to become part of a permanent historical display. The contest was credited by dealers with having created store traffic, turned up "hot" prospects for new RCA Victrolas, and developed many opportunities to demonstrate the great strides made in the field of recorded music since the old acoustic days.

The winning dealers, together with
(Continued on page 703)

OPPORTUNITY? Of course there's opportunity in radio—just as much today as when it was a brand-new industry instead of one of the country's biggest. Look at the 6 men pictured above. Do you want a job like theirs? All you need is to work like they did; to use judgment like they did;—and to have the judgment to use!

AN EDITORIAL

By Artie Dee

Work, Brains & Luck.

Those are the ingredients that go to make up success—and their importance is in the order named, with work an easy 1st and luck a bad 3rd.

The formula for success in any line of endeavor is exceedingly simple. First, use the Brains to prepare a sound plan.

Then Work like the dickens to put the plan into effect.

Finally (and there is no way you can control this) have a little Luck, to keep circumstances—which you can neither foresee nor control—from wrecking your plans and making all your work go for naught.

The Brains are important. They will help you evolve the best possible plan, and it is easier to follow a good plan than a poor one. But Work is of even greater importance; it will enable you to put over a good plan in a big way, or to make a less perfect plan operate. There is no substitute for hard work and plenty of it.

If Brains and Work were the only ingredients necessary for success, the world would know few failures. But no man can control his luck. You may have a business that is doing well, and a price-cutter opens across the street. Or

the man who owns the building where your shop is located may find another tenant who will pay twice your rent when your lease expires—after you have built up a good neighborhood clientele. That's luck — bad luck. It can give you an awful set-back, but it can't ruin you completely as long as the Will to Work lives on in you.

Get your brains busy. Buckle down to work. When your luck turns—and it always does turn—you'll find that Work Will Win.

OFF THE PRESS

Latest Publications to Keep You Informed

1939 RADIO CATALOG. Montgomery Ward, Chicago. 56 pp. Parts, sets, accessories at retail. Installment plan in upper brackets.

RADIO TESTERS. Triplett Elec. Inst. Co., Bluffton, O. 4 pp. Wide variety of test units and meters.

INSTRUMENTS (Price Sheet 50-1) Same co. 4 pp. Prices and specifications on wide range of meters.

NEW 1939 AUTO ANTENNAS. RCA Mfg. Co. 2 pp. Noiseproof cowl antenna, rod antenna and 4 others pictured, priced and described.

TELEVISION FOR YOUR HOME. Allen B. Du Mont Labs. 8 pp. Descriptions and color illustrations of home sets.

VOLUME CONTROL GUIDE. International Resistance Co., Phila. Data on IRC resistors.

CO-X. Transducer Corp., N. Y. C. 10 pp. Data on concentric cable.

1939 MOTOROLA. Galvin Mfg. Co., Chicago. 38 pp. Prices, pictures and descriptions of auto-radios and sales helps.

PRACTICAL WAX RECORDING. Universal Microphone Co., Inglewood, Calif. 34 pp. Hints on recording. 50c from mfr.

NEWEST AID TO HIGHWAY SAFETY



"Hey, youz! Where's the fire?" And meek motorists, daunted by cop's voice through Atlas "Marine Midget" speakers, installed by Haight's Radio Service, of Boise, Idaho, for Idaho State Police, get into line, obey the Voice of the Law. Used for street safety work & traffic direction, these all-weather speakers are mounted on special brackets devised by the service co. (Why aren't YOU doing this, too?)



Leading N.Y.C. dept. store took large ad to introduce Crosley Reado (home facsimile). Images were faint from demonstration record. On 1st day, about 400 looked it over; 2 bought. Reados were marked \$79.50, "reduced" from \$118—but mfr.'s catalog shows the lower price. Crosley rumored turning out 500 Reados a day. (Will they need that many?) Other rumor is that price will drop to "about \$20" for Reado, and 10c for 30-ft. paper roll, now \$1.

Norman S. Neely, Hollywood sales agent, has taken on a new acetate shaving collector, used in recording studios . . . Supplementary tube charts, test data, etc., are free to owners of Precision Electronometers, series 500, 500A, 510, 600, 700, 800, 815 & 900, if they address the mfr. & give serial no. . . . Philco's 937 auto-radios include P-B tuning, AVC, & tone control . . . G-E will spend \$2,500,000 on its new Chi plant, for which 77,000 sq. ft. of land have been bought.

Wholesale Radio Service Co. is out with a new line of Lafayette amplifiers

& sound systems in 3 price ranges; it's said to be the most complete ever presented by a single mfr. (See picture, next page). . . . NBC is sponsoring a contest to promote better merchandising of radio programs; prizes will be chimes. . . . There's a new World Listening Radio Map, by Philips Lamps, Ltd., of London.

Didja know the new Philco Refrigerator Co. plant has 212,000 sq. ft. of (Continued on page 704)

Sales Helps and Deals

Aids To Profits, as Devised By Industry Leaders

Sales of RCA radio tubes were boosted through distributor & dealer use of more than 12,000,000 pieces of promotion & display material in '38. This included some 27,000 complete window displays, 3,000,000 direct-mail post-cards, & 40,000 service engineers' pencils. Trade paper ads backed up the program.

(Continued on page 704)

PORTABLE RADIOS BACK WITH A BANG

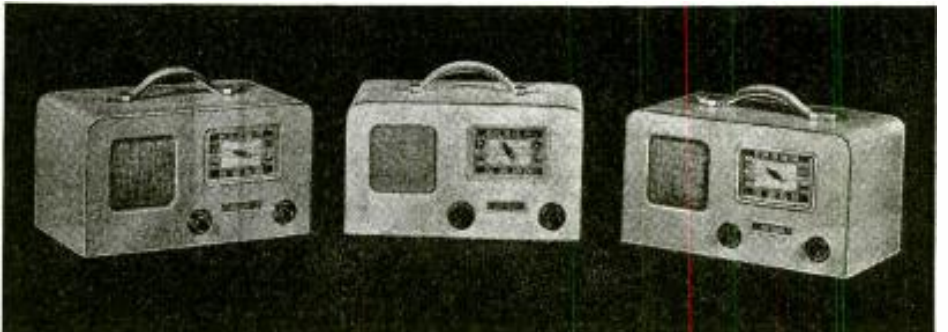

So great has been demand for portables that RCA has added 3 more to its line. Newcomers (l. to r.): buffalo hide, \$42.50; rawhide, \$44.50; cowhide, \$39.95. Original Pick-Me-Up (not shown): airplane cloth, lists at \$29.95. Phone adapter, \$2 additional.

Personal

These men are worth knowing; meet them here.

JIM KAY, of Tulsa, Okla., is factory rep. for *Universal Microphone Co.* in Okla., Kan., Ark. & W. Mo.

SAUL SHAPIRO, of Los Angeles, is Calif. rep. for *Nash Radio Products* recording lubricants & cleaners.

DR. WM. D. COOLIDGE, director of *G.-E.'s* research lab, was awarded the Faraday Medal for 1938 by the Institution of Electrical Engineers of England, for his achievements in electricity.

HOWARD BRIGGS, of *Howard Radio*, gives 1.4-volt tubes some of the credit for the boom in battery set biz.

CHAS. B. SHAPIRO, same co., says the public is still going heavy for consoles.

J. C. HAMMOND, for 17 yrs. with *Electric Storage Battery Co.*, lately sales mgr. in Chi territory, is now mgr. of nat'l acc't sales for *National Battery Co.*, with hq. in St. Paul, Minn.

IRVING F. GINN is back with *Radio Service Lab. of N. H.* His office will be at 34 Free St., Portland, Me.

Changes & New Addresses

Save stamps & time! Address your mail right the first time!

ELECTRO-VOICE MFG. CO. has moved to its own bldg. at 1239 South Bend Ave., South Bend, Ind. The co. makes dynamic, velocity & carbon mikes.

UNITED TRANSFORMER CO. has moved factory & offices to 150 Varick St., N.Y.C., occupying space 30 times as great as 5 yrs. ago.

RICHARD A. HYDE, 4253 Quitman St., Denver, Colo., is representing Howard Radio for ham receivers in Colo., Utah, Wyo., & N. Mex.

H. E. WALTON, 1014 Francis Palms Bldg., Detroit, Mich., is selling same co.'s same line in Mich. & Ind.

TEACHES C-R PRINCIPLES



Schools, shops, etc., are putting down their 50c for the Du Mont 2-color litho chart which explains the essentials and applications of the C-R tube. Sold below cost, it will not be reprinted—maybe.

Television Tips

Farnsworth Tel. & Radio Corp. has filed an SEC statement on 660,000 shares, 600,000 (\$1 par) of which will be sold to public. The co. will use most of revenue (nearly \$5,000,000) to take over Capehart, Inc., & General Household Utilities Co. Co. will move to Ft. Wayne, Ind.

Will the new Model L light valve, developed by Phonotone Labs for movie recording, start a new swing toward mechanical television? (Watch for this mfr.'s new sound line, too.)

RCA denies it has formed subsidiary to handle telly, but admits step may come. Rumor is that new co. may be Television Corp. of Amer. Old-timers may remember another TCA of some 8-10 yrs. ago.

Western Union has inaugurated a telegraph facsimile service.

Radio Corp. demonstrated television
(Continued on page 704)

\$'s & No.'s Dept.

"Eupompus Gave Splendor to Art By Numbers"—Ben Jonson

JOINT COMMITTEE on Radio Research has released report on rural radio. Most significant figures, however, appear in survey's combined rural & urban totals:—

Total U.S. Families	32,641,000	100%
Total Radio Families	26,666,500	82%
Ditto with 2 or more home sets	3,954,041	14.8%
Ditto with auto-radio	4,639,438	17.4%
Median listening hours (daily)	4:22	

STILL GROWING, NBC nets now have 173 affiliated stations.

UPS & DOWNS in network billings for Jan.:—NBC, \$4,033,900 (up 6.3% over Jan. '38); CBS, \$2,674,057 (down app. 7%); MBS, \$315,078 (up 16.7%).

ALL STATIONS' gross for '38 was over \$150,000,000 for time; about \$17,000,000 (estimated) for talent.

BRITISH EXPORTS, unlike those of U.S., upped in '38. Figuring the pound at \$5, the take was \$8,973,960 for '38; \$8,267,095 for '37. Reason: xmtrs upped 40%; receivers, 12%.

LATEST CENSUS of U.S. mfrs. of sets, tubes & phonos is for '37. Following figs. don't include plants producing less than \$5,000 per yr.

No. of establishments	162
No. of wage (not salary) earners	48,343
Wages	\$52,000,000
Value of products	\$277,800,000

Breakdown shows:

Receiving sets, complete	\$172,168,000 more than 1/2 of which are multi-band
Tubes, receiving	\$39,250,000
Tubes, xmtg.	\$3,004,000
Phonographs	\$7,086,000
Records (not E.T.)	\$4,755,000
—and other miscellaneous classifications (in which loudspeakers, for example, accounted for more than \$9,000,000)	

TOTAL EXPORTS of American radio in 1938 were \$23,100,060, a decrease of \$9,257,357 or 28.6% from the
(Continued on page 704)

THREE NEW SOUND LINES



The Economy, Standard & De Luxe are the 3 new Lafayette sound lines presented by Wholesale Radio Service Co. Shown is 15-tube 70-watt model with 4-mike, 2-phono inputs; 160-watt peak; 127 db. mike gain; many features; at \$61.95.

NEW LOW PRICE LEADER

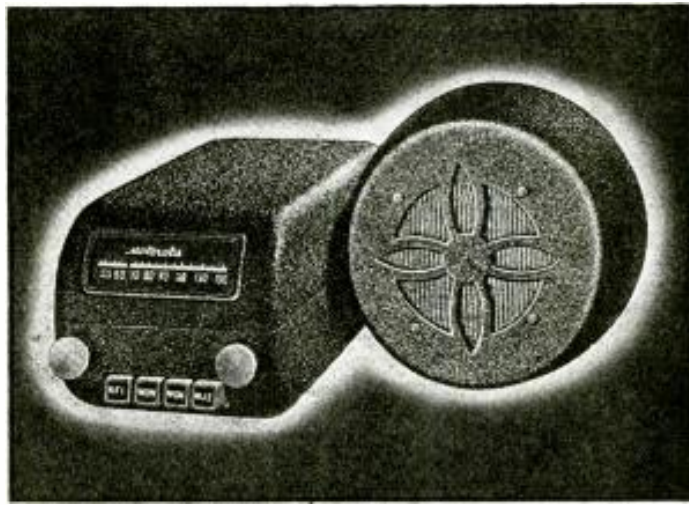

At the lowest price in Motorola history, the 2-unit Model 9-24 is a 6-tube, 4-pushbutton superhet. listing at \$24.95. Other models in the line range from \$29.95. to \$69.95. New item is hi-sensitivity set at \$44.95.

WANTED - - - radiomen - - - to make profitable sound installations

De Luxe VOCAGRAPH Amplifiers and Complete Systems



For Every Sound Application — at New LOWER PRICES

5-WATT Amplifier only, with high gain for crystal or dynamic microphone, tone control, etc. list \$24.50
Complete 5-watt portable system including crystal microphone, table stand, amplifier, leatherette carrying case, 8" p.m. speaker, etc. list \$50.00

12-WATT Amplifier only, with high gain input, separate microphone and phono input controls, tone control, 4 and 8 ohm output taps, for use with any p.m. speaker list \$32.50
Complete 12-watt portable system, including high grade dynamic microphone, 25-ft. microphone cable, stand, heavy duty 8" p.m. speaker and 25-ft. cable, amplifier, etc. list \$75.00

20-WATT Amplifier only, with two high gain input channels, phono input, pilot light, tone control, variable output impedances, four stages, push-pull 6L6G output list \$47.50
Complete two speaker portable system including new clipper dynamic microphone, stand, amplifier, three-piece carrying case, two 10" p.m. speakers, etc. list \$118.00

30-WATT Amplifier only—a new value in high power equipment. Dual high and low note electronic tone compensators, two high gain input stages, etc. list \$66.50
Complete two speaker portable system list \$150.00

Forty and One Hundred-Watt Super Power Amplifiers are also included in the VOCAGRAPH line to cover the largest indoor auditoriums and stadiums. See catalog for complete descriptions.

NEW—6 and 110 Volt Mobile Systems



Marvels of modern engineering. Afford equal power and full output on either 6 volt battery power supply or 110 volt power line.
38-WATT—Highest power battery and line operated amplifier ever built. Built-in phono for sound truck or stationary operation.
28-WATT—A high power mobile amplifier offered for the remarkably low price of \$90.00 list with built-in 6 and 110 volt power supplies.
15-WATT—A new low

price for combination battery and line powered amplifiers. Costs but little more than many straight a-c amplifiers of similar output.
For complete specifications, get the new VOCAGRAPH catalog. FREE on request.

Big Dealer Discount — Write for information and new catalog!

Let me help you get started in this big field

I can show you how to make money every month in the year, installing modern sound equipment—right in your own community.

Every church, club, school, stadium and countless restaurants, dance halls, factories, warehouses, lumber yards, etc., need the convenience of VOCAGRAPH Sound Equipment.

Our engineers have developed a new kind of "Package Sound Equipment" that is shipped ready for installation. Nothing else to do. Quick and constant profits.



John Meck

FREE — ENGINEERING SERVICE

No special technical training is needed to enter this profitable field. All you need to do is send our engineers data on the premises to be covered by the sound installation—and they will provide you with complete specifications, including every possible detail. Twenty-four hour service on every job.

Because every VOCAGRAPH unit from microphone to loudspeaker is carefully matched at the factory, you are assured of 100% satisfaction on every installation.

300 VOCAGRAPH FACTORY DISTRIBUTORS To Serve You

No matter where you are, you can get VOCAGRAPH equipment overnight for any installation. If you have the VOCAGRAPH FACTORY FRANCHISE for your community, they will assist you in demonstrations and provide time payment plans for the use of your customer.

TIME PAYMENT PLAN

It is easy to qualify for the VOCAGRAPH FACTORY FRANCHISE. Act now while this special offer lasts. You get free letterheads, business cards, and wall or window signs. A powerful VOCAGRAPH Demonstrator SOUND SYSTEM that you can use for profitable rental jobs will be supplied for as little as \$10.00 down and the balance in convenient monthly payments. Act now, while the franchise is still open in your community.

Write for
full details

TODAY!



VOCAGRAPH SOUND SYSTEMS

Div. of Electronic Design Corp.,
162-D N. May Street, Chicago, Illinois, U.S.A.

**ACT
NOW**

Send me at once full details on the VOCAGRAPH FACTORY FRANCHISE for my community, including your offer of free letterheads, business cards, and time payment plan that brings a modern high power demonstrator sound system for as little as \$10.00 down. There is no obligation to me.

Name

Address

City State

Please Say That You Saw It in RADIO-CRAFT

SUPERIOR PRESENTS 7 INSTRUMENTS

Never before has Superior offered so much for so little! Always the Best Buy in the Instrument Field, Superior in this new 1100 series gives you even more value! We have incorporated many refinements,

SUPERIOR INSTRUMENTS ARE

THE NEW MODEL 1110-S A.C. - D.C. VOLT OHM MILLIAMMETER

A Midget in Size—A Giant in Performance



Features modern 0-1 d'Arsonval type meter, precision resistors, neat etched panel housed in new striped fabricoid case.

SPECIFICATIONS:

0-1.5 volts D.C.	0-500 ohms.....	500-500,000 ohms.	0-15 volts A.C.
0-15 volts D.C.	0-1 ma. D.C.		0-40 volts A.C.
0-25 volts D.C.	0-10 ma. D.C.		0-75 volts A.C.
0-75 volts D.C.	0-100 ma. D.C.		0-200 volts A.C.
0-500 volts D.C.	0-500 ma. D.C.		0-1200 volts A.C.

Model 1110-S supplied complete with batteries, test leads and instructions. Size: 8 1/2" x 5" x 3 1/4". Shipping weight, 5 1/2 pounds. Our net price.....

\$7⁸⁵

THE NEW MODEL 1130-S

Signal Generator with Audio Frequencies



SPECIFICATIONS:

1. Combination R.F. and Audio Signal Generator. R.F. 100 kc. to 100 Mc., A.F.—100-7,500 cycles. All Direct reading, all by front panel switchings.
2. R.F. and A.F. output independently obtainable alone or with A.F. (any frequency) modulating R.F.
3. Accuracy is within 1% on I.F. and Broadcast bands; 2% on higher frequencies.
4. Audio frequencies in 5 bands; 100, 400, 1000, 5000, and 7500 cycles.
5. Giant airplane full vision, direct reading dial.
6. Condenser and other leakages tested to 100 megohms.
7. All services on 90-130 volts A.C. or D.C. (any frequency).

Model 1130-S comes complete with tubes, test leads, carrying handle, instructions. Size 12" x 9" x 6 1/2". Shipping weight 15 pounds. Our net price.....

\$11⁸⁵

THE NEW MODEL 1150-S SUPER-ALLMETER

Featuring the New Sloping Panel



A genuine achievement! For accurate and rapid measurements. Note the following features: A.C. and D.C. Volts, A.C. and D.C. currents, Resistance, Capacity, Inductance, Decibels, Watts.

SPECIFICATIONS:

- D.C. Voltage: 0-15, 0-150, 0-750 volts D.C.
- A.C. Voltage: 0-15, 0-150, 0-750 volts A.C.
- D.C. Current: 0-1, 0-15, 0-150, 0-750 ma. D.C.
- A.C. Current: 0-15, 0-150, 0-750 ma. A.C.
- Resistance Ranges: 0-500 ohms, 500-5 megohms
- High and Low Capacity Scales: .0005 to 1 mfd. and .05 to 200 mfd.
- Decibel Ranges: -10 to +19, -10 to +38, -10 to +53.
- Inductance: 1 to 700 Henries
- Watts: Based on 6 mw. at 0 D.B. in 500 ohms. .008000 to 600
- Utilizes new 4 1/2" square 0-1 d'Arsonval type meter with precision resistors housed in our newly devised sloping case for rapid and accurate servicing.
- Model 1150-S supplied complete with test leads, tabular charts and instructions. Size 10" x 7 1/4" x 4 1/4", shipping weight 9 pounds. Our net price.....
- Model 1150-A Portable carrying cover 75c additional.

\$11⁸⁵

THE NEW MODEL 1180-S SET TESTER

A Complete Laboratory All in One Unit!

Featuring Our New Type Sloping Panel for Precise and Rapid Servicing



A complete testing laboratory all in one unit! Combines Superior models 1140-S and 1150-S. For specifications read the description of both these models herewith. Comes housed in sturdy, black case with sloping panel for rapid and simple measurements. Complete with test leads, tabular charts, instructions and tabular data for every known receiving type tube, including many transmitting types. Size 11 1/2" x 9 1/4" x 5 1/2"; shipping weight 18 pounds. Our net price.....

\$17⁸⁵

Model 1180-A for Portable Cover, add 95c.

THE NEW MODEL 1140-S TUBE TESTER



A really modern tube tester conforming to all standards of good engineering practice. Utilizes a 3" d'Arsonval type meter with calibrated scale. Furnished in a sturdy black case with sloping panel for easy operation. Removable cover and carrying handle for either portable or counter use.

SPECIFICATIONS:

1. Tests all 4, 5, 6, 7, 7L, and octal base tubes, including diodes.
 2. Tests by the well established emission method for tube quality, directly read on the GOOD! (IAD) scale of the meter.
 3. Affords separate neon test for leakage and shorts between elements.
 4. All services performed by the use of only five controls at maximum, and many tests do not require working all the controls.
 5. Supplied with instructions and reference table so that the filament voltage and emission measuring controls may be properly set for the enumerated long list of tubes, which includes all tubes commonly encountered in servicing.
 6. Works on 90-120 volts A.C. 60 cycle.
- Model 1140-S comes complete with instructions and tabular data for every known receiving type of tube as well as many transmitting types. Shipping weight 10 pounds, size 10" x 7 1/4" x 4 1/2". Our net price.....
- Model 1140-A with Portable Cover 75c additional

\$10⁸⁵

SUPERIOR INSTRUMENTS CO. 136 Liberty St., RC-5 NEW YORK, N. Y.

Please Say That You Saw It in RADIO-CRAFT

FROM ITS NEW 1939 1100 SERIES!!!

many new features . . . all proven to be sound and practical. We urge you to read the descriptions be-

low carefully; see how these instruments fit your needs. Buy direct from manufacturer and save 50%.

GUARANTEED FOR ONE YEAR

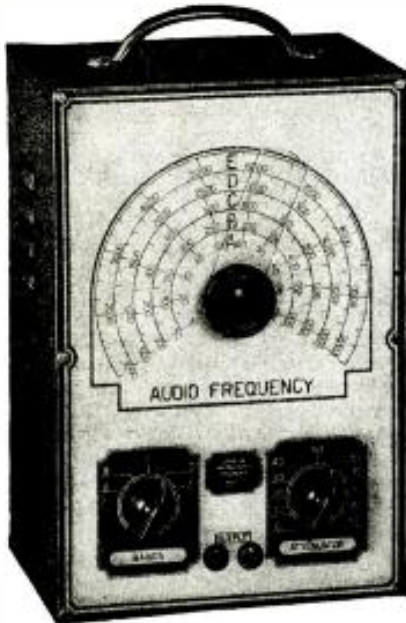

THE NEW 1190-S AUDIO OSCILLATOR

Continuously variable from 0-10,000 cycles

1. Checks distortion in P. A. systems and audio amplifiers.
2. For checking Sweep voltage in television receivers and transmitters.
3. Frequency checks for the hard of hearing persons and for the use of hearing aids.
4. Centralizing trouble in audio circuits in receivers and P. A. amplifiers.
5. A. C. source for Wheatstone and Universal bridges.
6. Checks frequency response in P. A. systems for use in recordings.
7. For checking frequency responses of microphones and speakers.

SPECIFICATIONS:

1. Direct reading in frequencies 0-10,000 cycles in 5 bands, all fundamentals, by front panel switching. 2. Continuously variable from 0-10,000 cycles, with 45 inches of calibrations etched on front panel. 3. Operates on 90-120 volts A.C. or D.C., any frequency. 4. Utilizes 3 tubes—one oscillator, one rectifier and one amplifier tube. 5. Positive attenuation from 0-2 volts maximum. 6. No dead spots. 7. Housed in beautiful black wrinkle finish shielded cabinet, with etched aluminum panel and carrying handle.

Model 1190-S, complete with tubes, leads and instructions. Shipping weight 8 pounds. Our net price.....

\$8⁸⁵

THE NEW MODEL 1175-S FREE POINT ANALYZER UNIT

Complete with portable carrying case and cover



May be used with any multimeter or set tester for testing by the point-to-point method of isolating and locating trouble.

SPECIFICATIONS:

1. Enables you to test tubes by the plate current method when used in conjunction with any multimeter. 2. Rapid current measurements under actual operating conditions without opening circuit for meter insertion. 3. Enables you to locate defects in any particular stage without removing chassis from cabinet. 4. Permits rapid and precise voltage and resistance measurements between any two points in a radio receiver, terminating at a tube socket. 5. Standard R.M.S. numbered tube chart for quick identification of tube elements. 6. Sockets are all R.M.S. coded. Complete with six slip-proof adapters, slip-proof type analyzer plug, dual insulated grid cap. 7. Etched aluminum panel, housed in leatherette covered portable type cabinet, cover included.

Model 1175-S complete in carrying case and cover, with all accessories included, all necessary adaptors, plug, R.M.S. coded tube base chart and instructions. Shipping weight 7 pounds. Our net price.....

\$8⁸⁵

ORDER DIRECT FROM US . . . ADDRESS ON PRECEDING PAGE

D.C. TO A.C. CONVERSION—USING POLARITY CHANGERS

(Continued from page 661)

plied with a frequency control due to the fact that a constant 60-cycle frequency is not essential for amplifiers or similar equipment.

A.C.-D.C. POWER SUPPLY

The polarity changer principle of conversion has proved very popular as a method of manufacturing a universal device such as an amplifier and in Fig. 5 a circuit is illustrated showing the power supply end of a universal, automatically selective device capable of operating on either A.C. or D.C.

The input line plug may be inserted in either an A.C. or D.C. socket and the circuit will automatically select either the vibrator and transformer, or the transformer, as a method of supplying power to the amplifier. By means of this arrangement a portable amplifier can be used in conjunction with an A.C. turntable motor where the turntable motor is operated from a winding of the transformer. It has never been practical before to operate a synchronous turntable motor on direct current but now the advantages of a constant-speed motor can be obtained even on D.C. lines.

A further innovation of the use of polarity changer type of converters is shown in Fig. 6 where the input voltage to the circuit is 40 volts A.C. at 25 cycles and the output from the circuit is 19 volts A.C. at 60 cycles. This circuit is used for the operation of A.C. automatic tuning motors when it is desired to operate the motor on a 25-cycle line. Other frequency changers can be made that will convert any frequency alternating current into a constant-frequency 60-cycle output.

RESUME

It can readily be seen that an advance has been made in the art of converting D.C. to A.C. particularly when one considers that the efficiency of a polarity changer converter is usually in excess of 95% in comparison to 50% for rotary converters, and 75% for the conventional type of vibrator types of converters.

For 110-volt D.C. conversion, there can be no substitute for the characteristics of the polarity changer converter due to the fact that no transformer is necessary, consequently, the weight of even a 250-watt unit is only about 3 lbs. in comparison to 40 to 60 lbs. for its equivalent in a rotary unit.

Further developments are continually being made in this type of equipment and undoubtedly, in the near future polarity changer devices will be operating practical-

ly any type of alternating current equipment on direct current lines regardless of the watts power or the characteristics.

This article has been prepared from data supplied by courtesy of Electronic Laboratories, Inc.

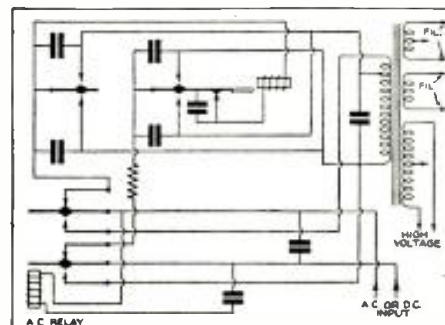

Fig. 5. Power supply portion of a universal and automatically-selective device for optional operation on A.C. or D.C.

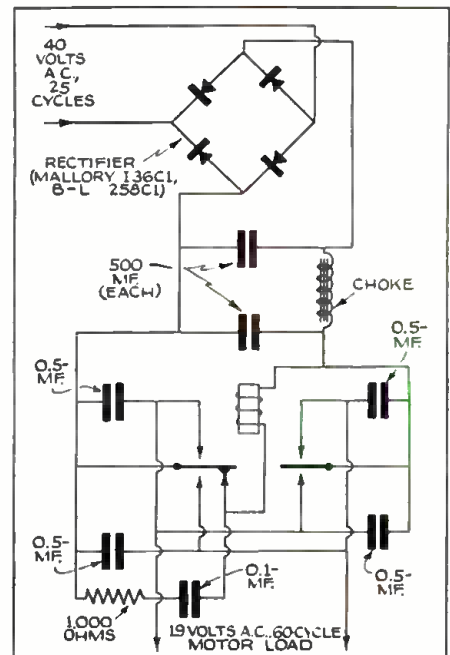

Fig. 6. This type of polarity changing converter permits operating a 60-cycle automatic tuning motor on a 25-cycle line.

Please Say That You Saw It in RADIO-CRAFT

A REAL HOWARD Communication Receiver*

COVERS BROADCAST
WAVELENGTHS DOWN
TO 7 METERS



Model 430

BUILT with
Traditional
HOWARD
QUALITY

Only
\$29⁹⁵
net

4 Bands—6 Tubes
Built-in Speaker
Complete ready to
plug-in A.C. Outlet

HERE is a radio set that will thrill every lover of distant and short wave reception. An ultra-sensitive receiver with electric bandspread to separate stations. You can listen to everything on the air from .54 MC to 43 MC (7 meters to 555 meters), foreign, domestic, amateur and commercial, broadcasts and code! Model 430 is now used by thousands of amateur stations, aeroplanes, ships, forest patrols, police, armies and navies the world over. *For \$12.50 additional the new model 610 D1 power supply now makes the 430 communication receiver available for use in your home on 110 volts AC and you can use it on six-volt storage battery operation for portable and emergency use; on your Summer vacation; camping, Marine or pleasure boat use. The model 430 also makes a dandy mobile receiver for the popular 10 meter band, for auto and trailer installation.

Here's the greatest value in the communication field for only \$29.95! A hand-built Howard with the custom parts, fine engineering and spectacular performance; features of communication receivers selling for twice the price or more. Check these outstanding features: 4 Bands—broadcast to 7 meters inclusive. Ceramic Coils, Iron Core III, Q. I.F. Transformers, Electrical Band Spread, Excellent Ultra-High Frequency, and eleven additional communication features.

*Pacific Coast and Export Prices Slightly Higher
America's Oldest Radio Manufacturer

Free Send Coupon for Technical Data and Name of Nearest Parts Jobber

HOWARD RADIO COMPANY
1731-35 W. Belmont Ave., Chicago, Ill.

Please send me data on Models 430, 438 and 439A

I desire demonstration of Model 430.

Name

Address

City State RC-539

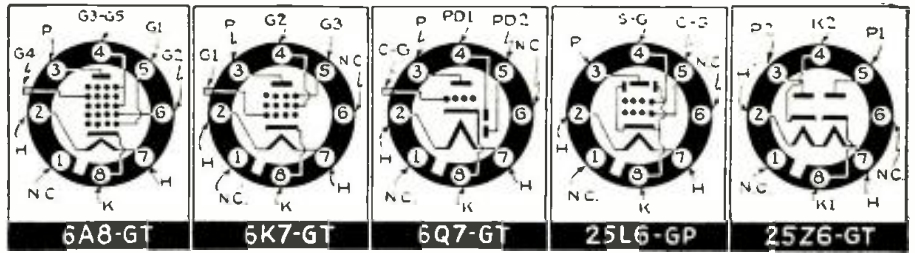

48 NEW TUBES

(Continued from page 659)

age to the small cabinet gives the illusion of a still greater image than that obtained with an even larger tube in a more bulky cabinet.

Although the new 9-inch stubby videotron has internal as well as external improvements, it is interchangeable with the old "long-type" tube without any altering of the television receiver circuit. Particular innovations are applied in the deflection method to correspond with the change in the "image penciling" angle caused by reducing the distance between the tube's base and screen.

The screen end of the "stubby" tube is bowl-shaped rather than funnel-shaped, and a wider neck permits many manufacturing advantages. Also, the unique shape of the new videotron permits machine-sealing along lines used in production of ordinary radio receiving set tubes; this single feature should bring down the cost of television tube manufacture.

Characteristics—Unannounced. A symbol for this tube has not yet been released.

2203 "Mary Eastman" Monotron—3-in. Electrostatic-Deflection type Signal-Generator Cathode-Ray Test-Pattern Tube

A pretty girl has joined science in aiding television Servicemen, amateurs, experimenters, and engineers to pioneer in the practice of the television art.

Supplementing, and in some cases supplanting, the purely geometrical test pattern previously used in earlier type 2203 Monotrons, National Union's new "Mary Eastman" pattern tube features a sharp half-tone picture of this popular radio vocalist.

'Tis said that this use of a beautiful girl's portrait permits the highly-favored technical effects of transmitting and reproducing the highlights and shadows of a good half-tone subject. Also, it makes a more eye-soothing test pattern for amateurs and experimenters to use as a sort of "theme" signal.

Incidentally, Miss Eastman's picture was recently reproduced before an assemblage of 700 television enthusiasts. This single mass viewing from a single tube indicates that a tremendous number of viewers will "televise" her portrait within a brief time.

The type 2203 Monotron is basically a 3-in. cathode-ray tube in which the customary fluorescent screen on the inside-end of the bulb has been replaced with an aluminum plate on which is printed the special test pattern or picture (as the case may be). The test pattern may be reproduced in any desired size, depending upon the screen size of the receiving tube.

A pattern tube finds a use in all fields where an experimental television signal is desired which can be obtained at will, especially in locations where modern television transmission is not available. This field includes experimental laboratories, schools, colleges, radio clubs, radio experimenters, radio amateurs, and all others, such as radio set manufacturers, radio

broadcast stations, and trade schools, where the principles employed in modern television are under development and study. With the advent of modern television a pattern-tube signal generator will be found indispensable in servicing television receivers.

The picture detail provided in the geometrical-pattern type 2203 Monotron, if all the detail present is resolved, results in full 300 lines-per-picture area fidelity; for the Mary Eastman pattern 2203, the picture-area fidelity obtained, from a demonstration standpoint, is better than 300 lines.

Tentative characteristics—Table XXX.

INTENSIFIER-TYPE TELEVISION TUBE

Last month Allen B. Du Mont Labs., Inc. introduced a cathode-ray tube having an "intensifier" element which is said to mark the first fundamental improvement affecting sensitivity since the inception of cathode-ray tubes 4 decades ago. The "intensifier" is said to result primarily in larger and brighter television images at a given cost; but likewise is of major importance in other applications.

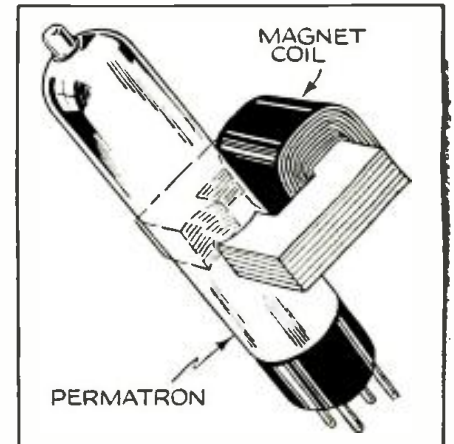

A magnetic yoke embracing the outside of the permatron's envelope affords control of heavy-current circuits as shown below.

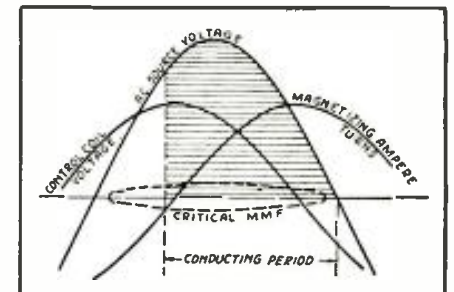

If an A.C. voltage is applied to the permatron's control coil an alternating magnetizing force (MMF) which lags the control coil voltage 90° is developed. Each value of voltage on the positive half-cycle of the A.C. source requires a corresponding critical magnetizing force to prevent conduction.

Please Say That You Saw It in RADIO-CRAFT

54-9-T, with Intensifier—5-in. Electrostatic-Deflection type Cathode-Ray Tube, with Intensifier Element

The *intensifier electrode*, as illustrated, takes the form of 1 or 2 metallic deposit rings near the screen end of the cathode-ray tube, and serves to accelerate the electrons *after* deflection.

So equipped, a tube has greatly increased brilliance without corresponding loss in deflection sensitivity. Heretofore, attempts at increasing deflection sensitivity while operating at given anode voltage, have been along lines of increasing deflection plate size and decreasing the space between. However, there is a definite practical limit as to how far one can go in this direction without seriously affecting the focus characteristics of the tube.

The Du Mont 54-9-T, 5-inch tube is provided with the intensifier feature, as well as several refinements in its gun structure to obtain better focus and modulating characteristics. In operation, the electron gun is operated at the same potentials and in the same manner as other Du Mont tubes of corresponding screen diameter. The intensifier electrode may be connected to the final anode and the tube operated in the conventional manner. If, however, an additional voltage equal approximately to the accelerating electrode potential be applied between intensifier and second anode, the effect of the former is to brighten the pattern equivalent to doubling the accelerating voltage, yet not causing so great sensitivity decrease as would normally result. In terms of screen pattern size, this means that, instead of a 50% reduction which doubled accelerating voltage would normally produce, the voltage with use of accelerating element reduces pattern size by only 18%. This simplifies deflection amplifier design.

The positive potential required between second anode and intensifier electrode may be taken from an existing cathode-ray tube power supply by the addition of a single half-wave rectifier operating from the same transformer winding and connected in reverse polarity. Filter requirements, because of the low current to this electrode, may be satisfied by the use of a light filter condenser and a high-resistance bleeder of approximately 10 megohms.

In the illustration on pg. 659, 1 is the cathode-ray beam; 2 is the trace; and, 3 is the phosphorescent screen.

Characteristics—Unavailable. Symbol, ditto.

LOWER-DRAIN "ACORN" TUBES

A group of 3 "acorn"-type tubes requiring only 50 and 100 ma. at 1.25 volts was announced last month by RCA Mfg. Co., RCA Radiotron Division. These tubes, described individually below, are of the direct-heater, coated-filament type; "previously, 'acorns' were available only in indirect-heater or 'cathode' type." They are designed for use in transmitters and receivers by amateurs and experimenters working at the ultra-high frequencies. Their economy of filament and plate power, and small sizes make them particularly useful in portable, battery-operated equipment.

The filament of each of these tubes can be operated without series resistance directly from a single flashlight drycell. As the photo shows, a special socket or "terminal mounting" is required.

These tubes may be operated either horizontally or vertically. Do not make soldered connection to the terminals. The excellent performance of these tubes at the ultra-high frequencies is due to the unconventional structure, which has small size, close electrode spacing, and short terminal connections. However, in order to realize the

(Continued on page 686)

NEW 3 IN 1 SERVICEMEN'S HELP!

1. Invoice and guarantee
2. Job record card
3. Follow-up mailing card

All in One!

IT'S SIMPLE—efficient—easy-to-use!
 This newest Sylvania "first" fills a long-felt need in the radio servicing business.

Just write out the invoice (on which is also printed your guarantee of satisfaction)—give it to your customer—and "presto", a carbon sheet has neatly filled out both the cardboard job record for your file and the follow-up mailing piece to be sent your customer later on. No repeat writing, no extra effort.

This Sylvania service form, with your imprint, is now available in pads of 25 sets each. Send today for

free sample or use the convenient order form below—or see your Sylvania jobber at once.

SYLVANIA

Set-Tested Radio Tubes
 Also makers of Hygrade Lamp Bulbs

HYGRADE SYLVANIA CORP. RC-59
 Emporium, Pa.

Please send me 100 sets—\$1.50, 250 sets—\$2.50, 500 sets—\$4.00. (Check one.) I enclose \$ in payment.
 Imprint (please print)

Name

Address

City State

Please Say That You Saw It in RADIO-CRAFT

Precision Engineered
Quality Built
Economically Priced

CINAUDAGRAPH SPEAKERS

for all service and public address applications.

Precision engineered—quality built—and economically priced Cinaudagraph Speakers have won wide favor in every phase of the radio industry. Sound engineers at the New York World's Fair picked Cinaudagraph Electro-Dynamics for the gruelling job of sound reproduction under all weather conditions. Manufacturers of radio receivers and public address equipment have found Cinaudagraph P.M. and Electro-Dynamic Speakers the answer to dependable service.

You too, can take advantage of the added "value" of Cinaudagraph Speakers. No matter what your replacement or "sound" requirement, there's a Cinaudagraph Speaker available. PRECISION ENGINEERED, QUALITY BUILT, ECONOMICALLY PRICED. Available at all leading distributors.



Literature on request.

CINAUDAGRAPH CORPORATION
STAMFORD CONNECTICUT

FREE!

Our new Catalog describing over thirty-two books in the "How to Make More Money" field has just come off the press. This catalog describes each book in detail. It enables you to select one or more books which will meet your requirements in an attempt to improve yourself financially.

Many of the books in the NATIONAL PLANS INSTITUTE catalog tell you how to start a spare- or full-time business of your own.

Write today for your FREE copy of the "NPI" Book Catalog—address a one-cent postcard to Dept. RC-539—and mail it today.

NATIONAL PLANS INSTITUTE
246-R FIFTH AVENUE, NEW YORK, N. Y.

ELECTRICITY

FROM YOUR OWN
ELECTRIC PLANT
WHEN POWER LINES FAIL

ONAN A.C. ELECTRIC PLANTS supply current for Radios, Transmitters and Receivers, P. A. Systems, Movie Projectors, Sound Truck Apparatus, Tolls, Lights, All Appliances. Used as Standby Equipment in Schools, Homes, Theatres and Public Buildings in case of Power Line Failure due to Storms, Floods, etc. Available in 110 or 220 Volt A.C.—12, 32 and 110 Volt D.C.—Also Dual Voltage A.C.-D.C. Types. Manual, Full Automatic & Self-Starting. \$99 and up. Shipped, Ready to Run.

D. W. ONAN & SONS
682 Royalton Avenue Minneapolis, Minn.



SOUND-ON-WIRE TAPE

(Continued from page 655)

bases less expensive than equivalent sound-on-disc equipment.

2—What is the tone quality of recordings? As curve B shows, excellent response can be obtained (± 5 db.) over the frequency range of 60 to 9,000 cycles (see curve 3) by utilizing a suitable attenuation network. This frequency range is obtained at negligible cost for the pickup head as compared to the expensive phono pickup which only professional sound-on-disc machines, as for instance those used in studios, would require for equivalent tone quality.

Another point, and one which the writer would like to stress here, is that *amplitude variations may be recorded at their proper levels*. Unlike disc recordings, which properly require automatic or manual *compression* during recording and automatic *expansion* during playback, sound may be recorded and played back on steel tape in the full beauty of its original and natural dynamic characteristics. This is true for the reason that the steel tape does not have the limiting factor of discs which is the ever-present possibility of the disc-cutter in the recording process cutting over to the adjacent groove.

3—How about background noise?

There is no contact noise, and with no amount of jarring or shaking of the apparatus either during recording or playback is it possible to produce any sounds but those that were recorded magnetically. Such background noise as is due to the molecular action that takes place within the steel tape is reproduced at a level about 40 db., or more, below the maximum signal level.

4—How long will these modern steel-tape recordings last? In contrast with earlier "iron wire" magnetic recordings these modern records, made on high-grade tungsten-steel tape 120 mils wide and 8 mils thick, should last more than a "lifetime." Even magnetic recordings made on poor-quality iron wire in 1903 are still "good" (to quote Prof. Harrison). Playback the recording has no appreciable effect on either the volume or the quality of the reproduction; in fact, and as one of the graphs shows, the barely perceptible volume loss of 2 db. does not occur until after 5,000 play-backs, and this may be compensated for in a second by a touch on the associated amplifier's volume control. Note how the signal output levels off after about 17,000 playings and continues constant, about 4 db. lower than the initial level, even after 180,000 play-backs. Recording diagonally through the tape (from top to bottom) and along the length of the tape results in a long path, through the steel, for the magnetic flux and contributes materially to the long life of these modern magnetic records.

5—How are re-recordings made and the old recording eliminated? Flipping a changeover switch to the Recording position alters the circuit so that, as the schematic diagram shows, a microphone (supplied with the soundmirror) is connected to the amplifier input, and the (combined) recording-playback "head" is switched from amplifier input to output in place of the reproducer (loudspeaker); at the same time a low D.C. polarizing voltage, applied to the head, generates a steady magnetic flux which is modulated by the signal (voice, etc.); the current is adjusted to about 5 ma. by means of potentiometer R.

Also, and simultaneously (if timer is in closed-circuit position), the second or *erasing* head is connected to a high D.C. polarizing voltage which serves to generate

a steady magnetic flux the purpose of which is to erase or obliterate all the old sound magnetic flux and thus prepare the tape to be acted-upon by the recording-playback unit operating as a recorder. A current of about 25 ma. is sufficient to saturate the tape (and thus obliterate any previous recordings).

In addition to the elements mentioned in the routines described above there are several other factors, both electrical and mechanical, embodied in the soundmirror which are worth special comment.

ELECTRICAL FEATURES

The soft-iron polepieces are held lightly against the steel tape by means of springs; and the magnetic forces which pull the polepieces into the tape are fairly weak. The polepieces, in the very nature of the way they operate, are practically self-aligning. Rust-preventing oil is used to lubricate and preserve the magnetic tape (perhaps one of the new non-rusting steels could be used—Author).

A change in speed of as much as 17% produces no marked change in quality! This, plus the fact that the pulleys develop a flywheel action, makes it easier to drive the tape with more practicable constancy

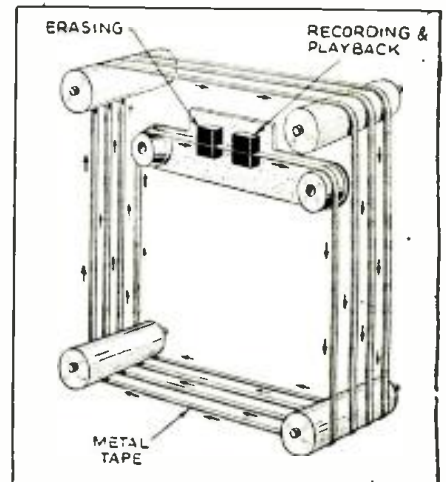

The tape is made endless by carrying it diagonally across, on two idler pulleys, from end to beginning of its helical form. The junction is welded.

(that is, without objectionable "flutter" or "wow") than is possible in either film or disc operation.

Coiling the tape *even though successive turns are in contact* does not affect the recordings! At present, a magnetic record is permanent at temperatures below 250°C. Also, they are practically unaffected by outside magnetic influences (magnetic storms, fields of nearby motors or transformers, etc.), because of the high magnetic strength used over a relatively short magnetic path in making the recording.

The total operating drain of the soundmirror, from the power line, is about 100 W.

The microphone input accommodates a low-impedance (50-ohm) unit. In the "HALF-HEAT" position of the power switch $\frac{1}{2}$ the operating voltage is supplied to the tubes merely for heating.

MECHANICAL FEATURES

The steel tape winds around and around 4 cylinders, one in each corner of the housing, 35 times to make a rectangular coil, and then cuts across inside the coil, diagonally, to join the beginning of the tape and thus

Please Say That You Saw It in RADIO-CRAFT

form a continuous winding; one of the 4 cylinders is driven by the small motor which keeps the coil in continuous motion in one direction.

Thus, if it is desired to immediately re-listen to a portion of the recording it is necessary to wait 2 minutes until that portion of the recording is again under the pickup coil, in this particular model of the soundmiror.

It is most convenient to run the tape through the recording-playback and erasing heads on the diagonal return-path of the tape. A slight amount of tension keeps the tape taut at all times. The welded joint is about as strong as any other part of the tape.

The endless helix has a recording length of about 360 ft. for making recordings 2 minutes long. Shorter lengths of tape may be used to obtain almost any desired length of "playing" time. In general, however, reels instead of a helix would be used for recordings much exceeding 12 minutes' duration.

Although the tape of the machine here described travels at the rate of 180 ft. per minute this speed may be increased or decreased within wide limits (depending considerably upon the required recording- and playback-frequency ranges) to accommodate other recording-playback durations.

The timer is electrically-driven by the synchronous motor which drives the tape and is set by means of the Timing dial on the instrument panel to repeat the playback after any predetermined period; it also controls the erasing current. One position of the power switch permits the power amplifier to be utilized in P.A. work, for call and announcement purposes, or as a phono amplifier; only in the "RUN" position of the switch is the tape drive motor put into operation.

APPLICATIONS OF THE SOUNDMIROR

(Continued from page 655)

be used to send traffic information and directions up to 400 yards by radio to be picked up in any radio-equipped car capable of tuning just above the broadcast band (on about 550 kc.). The Federal Communications Commission is considering this application as a means of aiding World's Fair traffic this summer.

In talkie studios, numerous recordings can be made on the steel tape and the final, perfected recording dubbed into the sound track of a sound-film. This represents a tremendous saving; particularly, when it is recalled that immediate steel-tape playback of each experimental recording is possible without any processing (developing, etc.).

Incidentally, May 1938 *Radio-Craft* contained the article, "37 Hours of Sound on Single 16 MM. Reel!". A diamond-stylus head indents 40 sound tracks side-by-side on a specially-prepared acetate cellulose film. A second, and similar, head affords immediate playback.

Also in May, 1938 *Radio-craft*, in "Make Your 'Silent' Movies into Home Talkies," a sapphire-needle recorder indents on the non-emulsion side of motion picture film. Same head, recording weight removed, plays back.

In March, 1939 *Radio and Television*, in "Records on Paper Tape from Mike or Phono," Merle Duston's sound-on-paper tape system was described. The recording stylus discolors, at audio frequency, a chemically-treated cellophane or glassene tape. For immediate playback the discolored tape interrupts a light beam directed on a photocell.—Author

CAN YOU TEST THE TUBES

they'll announce

NEXT MONTH?

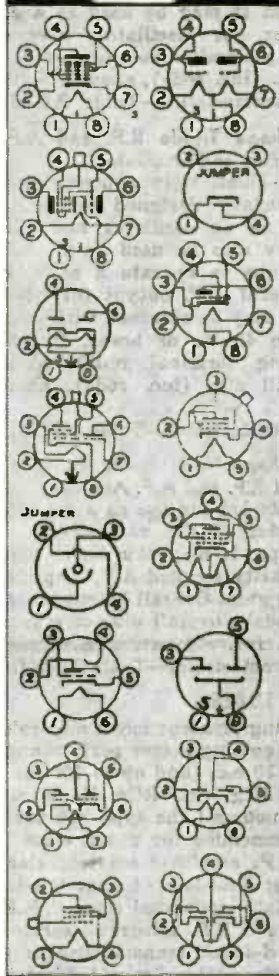
New filament arrangements just announced and to be announced are obsoleting thousands of tube testers. The demand for a better tube, one which would perform at higher frequencies, necessitated a mechanical change in tube design which resulted in the single-ended tube. This same mechanical change, primarily developed for television, has been incorporated in radio receiving tubes because of its many advantages. In changing the ordinary tube to a single-ended tube, filament termination can not be held constant; the grid gets the most consideration and the filaments have to look out for themselves.

At left are shown a few tube bases with different filament terminations. There are at present fifteen filament arrangements. But remember, there are 145 different filament terminations possible without considering center-tapped type filaments. Center tapped filament combination possibilities would raise this figure to several hundred.

Most tube testers in use today are already obsolete—the oft-bragged about spare socket is of little or no help, and the constant purchase of adapters will soon equal the original cost of the tester. So the average service-man must buy a new tube tester—not just for TODAY'S tubes but for the tubes which will be announced next month or next year.

ONLY SUPREME HAS THE PATENTED "DOUBLE FLOATING" FILAMENT RETURN SELECTOR PUSH-BUTTON SYSTEM!

No matter how filament terminations roam—no matter if they are center tapped or not—the SUPREME MODEL 504 "TOMORROW'S TUBE AND SET TESTER" will check them. With SUPREME'S unique and exclusive "Double Floating" Filament Return Circuit, you just press a button and the tube's filament is automatically connected across the filament potential supply, regardless of the tube's base terminations.

The Model 504 is not only the world's most complete tube tester but it is also a complete set tester and a complete condenser analyzer. You need full information on the Model 504 so we urge you to see this remarkable value in tube and set testing equipment at your jobber's TODAY, or, write for full literature on this and many other completely new 1939 models of SUPREME test equipment. Brand new literature just off the press! Model 504 cash price, \$55.50; or \$5.09 cash and 11 monthly payments of \$5.09.

NOTICE: Even if you wrote us last week, you still don't have the new illustrated literature, just off the press, covering the 504 and SUPREME'S complete 1939 line. Write for it TODAY!

SUPREME

SUPREME INSTRUMENTS CORP.
GREENWOOD, MISSISSIPPI, U. S. A.

EXPORT DEPT., Associated Exporters Co., 145 W. 45th Street, New York
Cable Address: LOPREH, N. Y.

MAIL COUPON TODAY!

SUPREME INSTRUMENTS CORP., Dept. C-4,
Greenwood, Miss.
Please RUSH me your newest literature on SUPREME 504 and many other completely new SUPREME 1939 Models.
Name _____
Address _____
City _____ State _____

Be a RADIO EXPERT - Learn AT HOME

RADIO SPECIALISTS NEEDED

Modern receivers with their complicated circuit systems have knocked out the old time cut-and-try radio fixer. Trained men with up-to-the-minute knowledge are needed to service these new sets.

HERE IS YOUR OPPORTUNITY

Your possibilities of making money and getting ahead are limited only by your ability and skill—but you must know more than the other fellow. You must be a radio service specialist, as R.T.A. can train you.

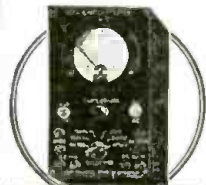

FREE

OF EXTRA COST

To start you making money without delay we equip you with this Circuit Analyzer and Point to Point Resistance Tester.

PRACTICAL TRAINING AT HOME

Our home study course is practical "shop and bench" training combined with a thorough set of practical lessons prepared by an experienced Radio service engineer. Four working outfits are also furnished.

MAKE SPARE TIME MONEY

Our training is complete and practical. We show you how to make money almost from the start. The course can easily be made to pay its own way. Investigate now, write for free book of details.

RADIO TRAINING ASS'N OF AMERICA
Dept RC-59, 4525 RAVENSWOOD AVE., CHICAGO

WHAT R.T.A. STUDENTS SAY

Norwood, Ohio
I have connected with a large firm as Radio Service Manager and wish to extend my thanks for your help.
Joseph Rupien, Jr.

Yorkville, Ohio
From Aug. 1 to Dec. 7, 1936, I repaired 163 radios and put up 43 aerials which is very good for part-time work while studying your course.
Chas. Koerber.

Please Say That You Saw It in RADIO-CRAFT

A LOT for YOUR MONEY



AEROVOX Type PBS card-board case electrolytics mean much capacity and working voltage for little money.

Ideal for new assemblies. Equally so as general-utility units for servicing in a hurry.

Adjustable flanges fit any hole spacing. Mount flat, upright, stacked.

25 v. to 600 v. D.C. working. Popular capacities. Single, double and triple section units.

Ask: your local AEROVOX jobber for PBS electrolytics. Get our latest catalog from him—or write direct.



★ NEW ATLAS 360° "Chandelier" SPEAKERS

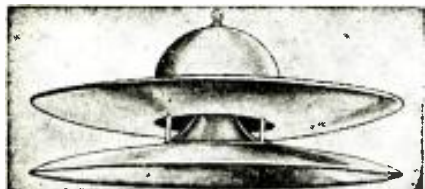

Chandelier Jr., complete with speaker Net \$7.35
Here's the P. A. speaker you have been looking for! The new Atlas "Chandelier" speakers give 360° uniform coverage . . . maximum amplification . . . minimum feedback. Microphone can be placed in "dead spot" directly under the "Chandelier" speaker . . . eliminates floor sound illusion. Try one on that next difficult P. A. installation. Ask your jobber about the new "Chandelier" speakers today.

Model S-360SP, with 5" P. M. speaker . . . Net \$7.35
Model L-360 for 12" speakers . . . Net \$16.17
Model L-360SP, with 12" P. M. speaker . . . Net \$24.40

***FREE—NEW ATLAS SPRING & SUMMER CATALOG**
Brings you information about "Chandelier" speakers and 101 money-making P. A. accessories. Send for this helpful catalog now!

ATLAS SOUND CORPORATION
1452 39th STREET, BROOKLYN, N. Y.

YOUR FUTURE IN RADIO TELEVISION

● These growing industries need trained men for sales, service, operation. Your chance for employment and advancement depends on thorough training. National Schools offer you time-tested training. Complete, modern facilities and equipment in the largest trade school in the West. Established 1905.

Send for free booklet that shows how you can prepare for these opportunities.



NATIONAL SCHOOLS
4000 S. Figueroa Street, Los Angeles

NATIONAL SCHOOLS, Dept. 5-11C, Los Angeles
Please send free Radio and Television Booklet.

NAME _____
ADDRESS _____
CITY _____ STATE _____

48 NEW TUBES

(Continued from page 683)

full capabilities of the tubes at these frequencies it is necessary to install the bypass condensers at the tubes in order to provide a short return-path.

957—"Acorn"-shape Triode Detector, Amplifier and Oscillator

This tube has a moderately high amplification factor. It may be used as a detector, amplifier, or oscillator. Overall height (including terminal rods), about 1 1/4 ins.; overall dia. (inc. rods), about 1 1/8 ins. Tentative characteristics—Table XXXI.

958—"Acorn"-shape Triode R.F. and A.F. Amplifier, and Oscillator

This "acorn," identical in appearance to the 957, is especially designed for transmitting service as an oscillator and R.F. amplifier. It may also be used as an A.F. power output tube to operate a sensitive loudspeaker. Useful A.F. output for headphone operation may be obtained with plate voltage down to 45 V., or lower. Overall height (including terminal rods), about 1 1/4 ins.; overall dia. (inc. rods), about 1 1/8 ins. Tentative characteristics—Table XXXI.

959—"Acorn"-shape Variable-Mu Pentode Detector and R.F. and A.F. Amplifier

The 959 is intended for use as a detector and R.F. amplifier of the variable-mu or remote-cutoff type. It may also be used as a resistance-capacity coupled A.F. amplifier having moderate gain. Overall height, about 1 1/4 ins. (inc. rods); overall diameter (inc. rods), about 1 1/8 ins. Tentative characteristics—Table XXXI.

TRANSMITTING TUBES

The transmitting amateur has a new tube to play with for getting better performance in the region of 30 mc. (and up to 100 mc.) now that RCA Mfg. Co., RCA Radiotron Division, has announced the type 810 tube. The 810 is recommended for u.-h.f. class B modulator or A.F. amplifier service; class B R.F. service, grid-modulated class C telephone service, plate-modulated class C R.F. service, and class C R.F. telegraph service.

A new *inverted-anode* transmitting tube, the ZP-248, developed by General Electric Co. for professional use is capable of delivering 5 kw. on 100 mc.

810—High-Mu Transmitting Triode R.F. Power Amplifier and Modulator

Very short internal leads and low internal inductance, in the type 810 tube, permit compact circuit layout for high-frequency installations. Because of its high perveance, this new tube can be operated at high plate efficiency with low driving power and relatively low plate voltage. In class C telegraph service, two 810's can be operated with the maximum input of 1,000 watts permitted for amateur use. Under these conditions, a power output of approximately 750 watts can be obtained from the two tubes. The 810 can be operated at frequencies as high as 30 megacycles with maximum ratings and at frequencies as high as 100 megacycles with reduced ratings.

The filament is of the thoriated-tungsten type. Characteristics—Table XXXII.

ZP-248—Inverted-Anode Transmitting Tube

The inverted-anode construction was developed to meet the need for a suitable, high-power transmitting tube in television and other ultra-high-frequency applications. High perveance, resulting in high efficiencies and adaptability to broad modulation bandwidths as used in television, has been achieved by constructing single-ended, water-cooled triodes in which the anodes are inverted on themselves to obtain extremely short lead lengths.

Characteristics—Unavailable. Symbol, ditto.

"PERMATRON" TRANSMITTING TUBES

Last month characteristics became available on Raytheon Production Corp.'s line of 3 "Permatron" or magnetically-controlled gas-filled control tubes. The magnetic field is obtained from a yoke in a manner somewhat analogous to the operation of electromagnetic-deflection cathode-ray tubes. The output of a thermocouple, fed into a field coil of proper design, is capable of controlling the Permatron!

More specifically, the permatron is a new gas-filled electron tube adapted to control of anode current by means of a small externally applied magnetic field. As in other gas-filled control tubes, the control determines the value of anode voltage at which the permatron starts to conduct, and does not influence operation while the permatron is carrying current. If a positive anode voltage, together with a magnetic field is applied, conduction will be prevented until the magnetic field is reduced to the value critical for that anode voltage. Once started, conduction continues until the anode voltage reverses or is removed.

In addition to the anode and cathode, the permatron contains a collector electrode which collects electrons diverted from the anode by the magnetic field and at the same time acts as an electrostatic shield to create a region of low electrostatic field intensity in which action of the magnetic field is most effective. In most circuit applications the collector is kept at cathode potential but is provided with a separate lead wire so that other potentials may be used if desired.

Three unique features of the permatron are useful in all of its applications: (1) The control magnet and control circuit may remain electrically insulated from the tube and its associated power circuit. (2) Reaction of the tube on the control magnet and control circuit is negligible. Permatrons may be used in circuits where it is particularly desired to avoid disturbances in

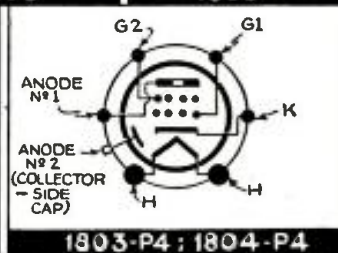
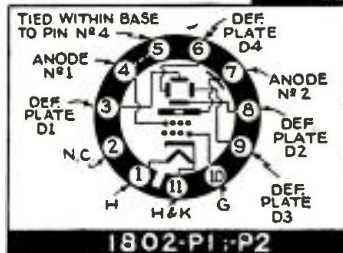
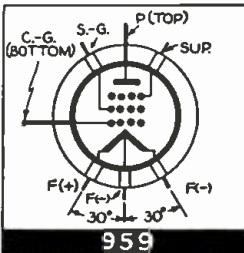
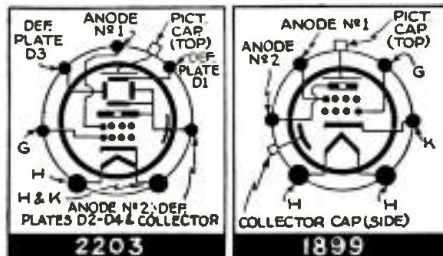

Please Say That You Saw It in RADIO-CRAFT

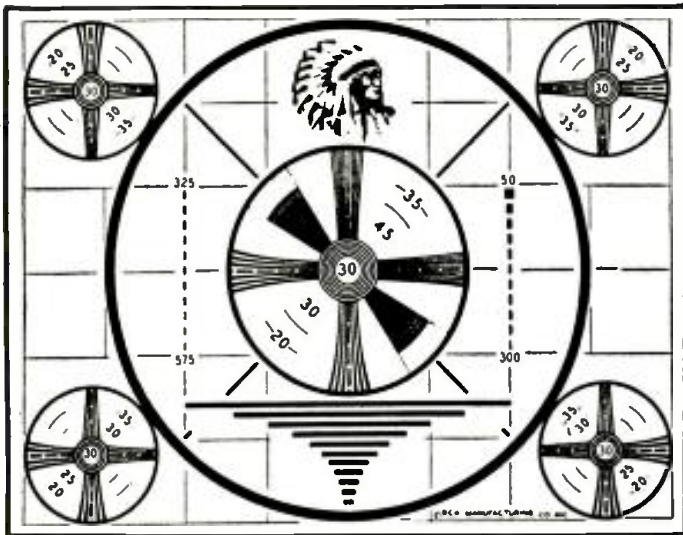

This combination geometrical and pictorial pattern on the end of the RCA Radiotron type 1899 Monoscope test-pattern tube has important use by the television Serviceman. Calibrated resolution wedges and lines afford test patterns for checking performance of every portion of a television receiver. The Indian-head may be scanned individually and adjusted to fill the entire image area of the cathode-ray receiving tube. The patterns are also useful in testing cathode-ray oscilloscopes.

the control circuit when the tube is conducting. (3) The control is independent of the polarity of the magnetic field.

RM-201 — Argon-filled, Directly-Heated Experimental Permatron
This control tube operates with the least maximum forward and inverse voltages of any of the permatrons, and consumes the least amount of filament current.
Characteristics—Table XXXIII.

RM-208—Mercury Vapor, Directly-Heated Permatron
The RM-208 was designed for application to controlled rectifier service for plate current supply to transmitting tubes. The collector lead is brought out through the base to permit grid control as well as magnetic control.
Characteristics—Table XXXIV.

RM-209—Mercury Vapor, Directly-Heated Permatron
This hot-cathode permatron was designed for use in high-voltage, controlled-rectifier circuits. A collector lead is provided to permit both grid and magnetic control. For operation above 1,000 V. peak inverse, the collector should be connected to the filament transformer center-tap; below 1,000 V., to the anode through a 50,000-ohm, 25 W. resistor.
Characteristics—Table XXXV.

MIDGET "STANDARD" TUBES
In comparison with the newer "cool" construction of midget-type tubes, as described previously in this article, the following group of 5 new tubes in the midget or "GT" series must be considered on a different basis; these new octal tubes, introduced recently by RCA Mfg. Co., RCA Radiotron Division, serve to round out the

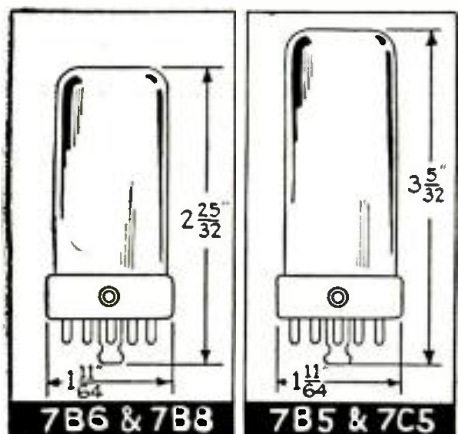

line in this particular class. These tubes have electrical characteristics similar to those of the corresponding metal types. Differing physically, however, these new types have tubular (T-9) glass bulbs.

6A8GT—Pentagrid Converter
Tentative characteristics—Table XXXVI.

6K7GT—Triple-Grid Super-Control Amplifier
Tentative characteristics—Table XXXVII.

6Q7G7—Duplex-Diode High-Mu Triode
Tentative characteristics—Table XXXVIII.

25L6GT—Beam Power Amplifier
Tentative characteristics—Table XXXIX.

25Z6GT—High-Vacuum Rectifier-Doubler
Tentative characteristics—Table XL.

7A6—TABLE I
Tentative Ratings and Characteristics

Heater voltage A.C. or D.C. (nominal)	7.0 volts
Heater current (nominal)	0.160 ampere
Direct interelectrode capacities:	
Plate No. 1 to Plate No. 2	0.05 mmf. (max.)
Operating Conditions and Characteristics	
Heater voltage	6.3 volts
A.C. voltage per plate (r.m.s.)	150 max. volts
D.C. output current	10 max. ma.
Voltage drop (per side) at 10 ma.	8 volts

7A7—TABLE II
Tentative Ratings and Characteristics

Heater voltage A.C. or D.C. (nominal)	7.0 volts
Heater current (nominal)	0.32 ampere
Direct interelectrode capacities:	
Grid to plate	0.005 mmf. max.
G ₁ —(f+k+g ₂ +g ₃)	6.0 mmf.
G ₂ —(f+k+g ₂ +g ₃)	7.0 mmf.
Operating Conditions and Characteristics	
Heater voltage	6.3 volts
Plate voltage	250 max. volts
Screen voltage	100 max. volts
Grid voltage	-3 min. volts
Suppressor	connected to cathode at socket
Plate current	8.6 ma.
Screen current	2.0 ma.
Plate resistance	0.8 megohm
Mutual conductance	2,000 micromhos
Amplification factor	1,600
Grid voltage for mutual conductance of 10 micromhos	-35 volts

7A8—TABLE III
Tentative Ratings and Characteristics

Heater voltage A.C. or D.C. (nominal)	7.0 volts
Heater current (nominal)	0.16 ampere
Direct interelectrode capacities:	
Grid G to Plate	0.15 mmf. max.
Grid G to Grid G _a	0.12 mmf.
Grid G to Grid G ₀	0.12 mmf.
Grid G ₀ to Grid G _a	0.60 mmf.
Grid G to all electrodes (R.F. input)	
Grid G _a to all electrodes except G ₀ (osc. output)	3.4 mmf.
Grid G ₀ to all electrodes except G _a (osc. input)	3.8 mmf.
Plate to all electrodes (mixer output)	9.0 mmf.

(Continued on page 690)

Please Say That You Saw It in RADIO-CRAFT

Dealers! Servicemen! Amateurs! Soundmen! Builders!

FREE

ALLIED'S Spring RADIO CATALOG

JUST OUT—SEND COUPON!

EVERYTHING IN RADIO AT LOWEST PRICES

NEW SETS!
New KNIGHT Radios, with Push-Buttons, built-in "Air-Magnet" aeriols—at new low prices! 60 models—Portable, A.C., AC-DC, 1½, 6, and 32 volt, etc., as low as \$5.95!—and radio's biggest line of record players, phonographs, phono-radios!

NEW SOUND!
New P.A. values for every purpose, 8-65 watts—Monitor Speakers, Remote Control, de luxe and standard models—permanent, portable, and mobile—and complete line of recording equipment, discs, etc.!

NEW KITS—PARTS!
More than 14,000 parts! New Build-Your-Own Kits: Meissner 1, 2, 3 tube, new "Pee-Wee"; Television; Mystery Phono and Mike Kit, and many others. Write for Free Parts Lists, New Builder's Handbook for beginners, only 10c.

NEW HAM GEAR!
Giant new Ham section—all new station-checking equipment to meet F.C.C. regulations. Rotary Beam Antenna Gear, Television Kit, new Hallicrafters, Howard, R.M.E. Models—all leading lines at lowest prices! See what's new!

NEW TESTERS!
All leading lines! See new equipment with provision for new Octal Tubes, etc.—Tube Checkers, Set Testers, Analyzers, Oscilloscopes, Meters—and over 14,000 parts at lowest prices!

Fastest Service, Highest Quality, Lowest Prices always! Write for ALLIED's new Spring Catalog!

Free!
SEND COUPON

ALLIED Radio Corporation, Dept. 2-E-9, 833 W. Jackson Blvd., Chicago, Ill.

Send me your new FREE Spring Catalog.

Enclosed find 10c (plus 3c postage) for Builders' Handbook.

Name

Address

City State

MAKE THAT OLD AUTOMOBILE RADIO BETTER THAN NEW

by installing a **MODEL VN8L SPEAKER**

The cabinet is made of steel yet has a soft suede finish, delightful to the eye and in harmony with today's car interior.



Model VN8L

The well known Nokoil Reproducer in this model VN8L will actually improve the performance of an old automobile radio to a point where it will be equal to or better than the present day automobile receivers.

The steel cabinet is arranged with a single stud mounting so that it carries the whole weight of the speaker. This eliminates the necessity of fastening the stud in the pole piece of the speaker which often throws it off center.



Write for complete information and catalog.

WRIGHT-DECOSTER, Inc.

2251 UNIVERSITY AVE., ST. PAUL, MINN.

New Performance Features at Amazing Low Cost!

Two New **TURNER** Microphones—**Dynamic 88, Crystal 66**



YOU get new advanced engineering and design at no increase in cost—in these handsome new Turner mikes. Ruggedness that assures tops in performance under severe operating conditions—weighted frequency response—Inertia mounted cartridges—narrow beam pickup of all frequencies—absolute wind and blast proofing, are exclusive features of these matchless new Turner models.

Send for Bulletin 41-A

Learn all about the latest developments in microphones. Details and applications of all models given in Free Bulletin 41-A. Know your stuff about mikes; write for your copy today!

MODEL 88
Get prize-winning "studio quality" with this professional mike. Order now.

\$25.00
LIST

The TURNER CO.
Cedar Rapids, Iowa

Licensed Under Patents of the Brush Development Co.

AMPLITONE'S PRIZE WINNER!



MODEL AM 15
15-20 Watt Beam Power Amplifier

Streamline chassis, electronic mixing, two inputs, inverse feedback, exclusive circuit, flat response overall. Net price, complete with matched tubes. **\$22.80.**

FREE! BIG 1939 P. A. CATALOG!

A Real Buyers' Guide for P. A. Equipment

AMPLITONE PRODUCTS COMPANY

135 LIBERTY STREET, NEW YORK, N. Y.

5-WATT VERSATILE AMPLIFIER

(Continued from page 649)

shunts the lossing resistor R1 (Fig. 2D). Inasmuch as the reactance of the choke Ch.1 decreases at lower frequencies, the effect of the lossing resistor R1 is gradually shunted out, so that a low-frequency boost is obtained, accentuation being greater at the lower frequencies. Likewise, when the center arm of the low-frequency control is turned towards ground, the low-frequency output of the preceding tube is shunted to ground, thereby producing an L.F. cut (Fig. 2E). A normal position is attained midway between the "droop" and "boost" positions.

In order to provide individual control of both the high and low frequencies, it is necessary to utilize separate controls in place of R2, as illustrated in Fig. 2F. This circuit diagram is now identical to the compensating network shown in the schematic diagram.

ASSEMBLING AND WIRING PROCEDURE

Figure 3 gives a chassis layout showing all necessary holes for mounting the various components. All of the various components should be mounted in place, as indicated in the illustration heading this article. The choke (Ch.3) and output transformer (O.T.1) are mounted underneath the chassis. It will be noted that all of the tubes are floated on a non-microphonic socket plate, so as to prevent microphonics from entering into the high-gain preamplifier section.

Normal precautions should be followed in wiring this high-gain amplifier, so as to avoid the introduction of hum in the pre-amplifier tube. All grounding should be made to a common bus bar so as not to pick up any chassis hum currents. The

tone-compensating network should be mounted near the input section of the amplifier. It is suggested by the writer that the builder should not attempt to construct the choke (Ch.1) because the effects of distributed capacity would upset the frequency-compensating range of the system. In fact, it is recommended that the entire tone-compensating network be purchased in a finished, factory-wired form so as to insure satisfactory operation of this important circuit.

List of Parts

RESISTORS

- One Erie Resistor Corp., 5 megs., 1/2-W.;
- Two Erie Resistor Corp., 5,000 ohms, 1/2-W.;
- Two Erie Resistor Corp., 2 megs., 1/2-W.;
- Two Erie Resistor Corp., 1/2-meg., 1/2-W.;
- Two Erie Resistor Corp., 1/4-meg., 1/2-W.;
- Two Erie Resistor Corp., 10,000 ohms, 1/2-W.;
- Two Erie Resistor Corp., 25,000 ohms, 1/2-W.;
- One Erie Resistor Corp., 0.1-meg., 1/2-W.;
- One Lectrohm, 160 ohms, 5 W.;
- One Lectrohm, 20,000 ohms, 20 W.;
- Four Centralab 1/2-meg. audio grid taper controls;

CONDENSERS

- One Mallory filter, triple 10, 45 V.;
- One Mallory filter, triple 10, 300 V.;
- One Mallory filter, triple 10, 150 V.;
- One Micamold, 0.006-mf., 600 V.;
- One Micamold, 0.001-mf., 400 V.;
- One Micamold, 0.1-mf., 400 V.;
- One Micamold, 100 mmf., 600 V.;

(Continued on following page)

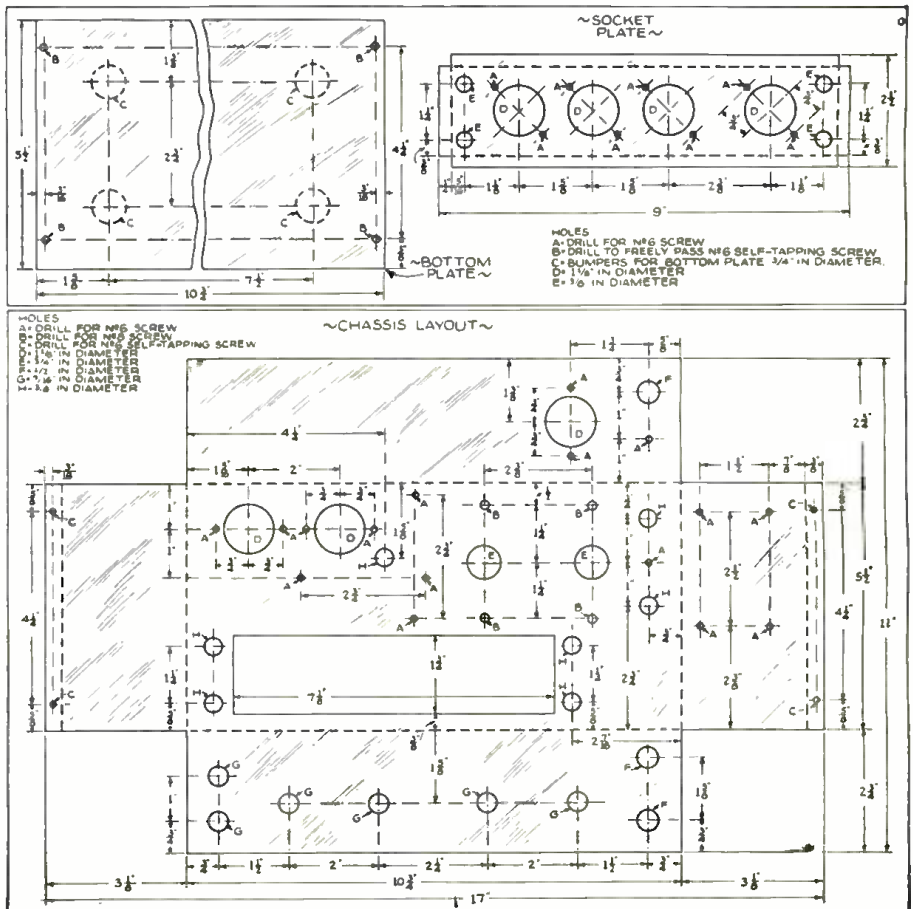

Fig. 3. Complete specifications for cutting and drilling the chassis, tube plate and bottom cover for the 5-W. versatile amplifier.

Please Say That You Saw It in RADIO-CRAFT

INTERMODULATION—AND ITS RELATION TO DISTORTION

(Continued from page 653)

present. If few and weak harmonics accompany a strong fundamental, the tone as a rule is soft and mellow. The presence of strong harmonics up to the 5th adds fullness and richness to the resultant tone. When overtones higher than the 6th are present, sharp metallic quality begins to appear.

For disruption of quality, harmonics cannot compare to discords. When a musician shows signs of insufferable agony, the chances are he is listening to discords and not harmonics. The phenomenon of discords evolves itself from those beat notes which are the intermodulation products of two frequencies whose resultant tones bear no simple integral relationship to either fundamental. When beat frequencies exceed 5 or 6 per second, they begin to sound unpleasant and as they increase in frequency, they increase in unpleasantness until a harmonic is approached. For two tones to sound pleasant, it is not only necessary that the fundamental tones shall not produce unpleasant beats, but such beats shall not be produced by intermodulation of their natural harmonics.

It is important for the "subjective distortionist" to realize certain classes of instruments (of which bells are a striking example) produce most annoying discords (apparent distortion) because these instruments produce overtones which are not harmonics (not multiples of the fundamental); and their overtones produce annoying beats either among themselves or with one of the fundamentals. It is for this reason that chimes are struck in succession and not simultaneously. It can safely be stated that most "subjective distortionists" (ear testers) would condemn a true high-fidelity sound system if they were to check its quality by listening to the amplified version of a number of bells struck simultaneously.

The usual laboratory methods of harmonic analysis, on the other hand, may cause "objective distortionists" to label a system "High Fidelity" because the total harmonics of a single signal do not exceed 5%. The extraneous frequencies however, capable of being produced through this very same system, with dual test frequencies, may easily exceed 15%. The intermodulation products which may be expected from two or more simultaneous test frequencies are liable to produce greater discord (subjective distortion) than would normally be expected from 2% or 5% of harmonics.

DISTORTION-MEASURING TECHNIQUE

It seems absurd to the writer, that speakers, microphones, phono pickups, tubes, amplifiers, etc., should be rated in per cent of harmonic generation based on single-frequency test signals, when under actual operating conditions, these components are normally subjected to a multiplicity of simultaneous complex signals which when passed through a non-linear system, will produce far more intermodulation products than simple harmonics. Furthermore, the detrimental effect of their frequencies (many of them will be unbearably discordant) are far more noticeable from a quality destroying standpoint than the usual accepted permissible standards of simple harmonics.

The apparent lack of recognition of the effect of intermodulation on permissible distortion has brought about a chaotic condition in amplitude distortion ratings. Arbitrary tests have set a standard of 5% (total harmonics based on a single signal) to be the noticeable point of distortion

when compared with a non-distorted signal. A 7% value has been the accepted standard for noticeable distortion without comparison to an undistorted signal. These ratings, however, have recently been found to vary, depending upon the transmitting frequency range of the system. When the transmitting range was extended to 18,000 cycles, 2% became noticeable by comparison with an undistorted signal and 5% became noticeable without comparison. This condition is undoubtedly brought about by the fact that many of the discordant products of intermodulation lie in the higher frequencies (check intermodulation products of 3,000 and 4,000 cycles).

Many sound technicians, laymen, and engineers have noted the desirability of high-frequency cut-off (turning the tone control down, in order to attain "pleasant" reproduction). Here, too, the discordant intermodulation products of a supposed-to-be "high-fidelity system" was raising havoc in the high-frequency range, and was therefore suppressed to avoid annoying intermodulation.

For a similar reason, pentodes, when originally introduced, did not gain rapidly in popularity because of an apparently paradoxical situation wherein 5% of total harmonics coming through a pentode sounded like 10% coming from a triode. The reason being, of course, that the higher order of harmonics (5th, 7th, 9th, 11th), generated in a pentode, were actually producing 10 or more per cent of discordant intermodulation products.

These undesirable conditions strongly suggest that a new method of measuring amplitude distortion be adopted by the sound industry. This new method should provide for the use of two or more standard and simultaneous sound frequencies so as to enable rating of microphones, speakers, tubes, amplifier, etc., in terms of total harmonics plus intermodulation products.

In the meantime, however, the author recommends that for true objective and subjective high-fidelity performance, equipment be used that does not produce more than 1% of total harmonics at the desired rated power output, as measured with a single frequency.

5-WATT VERSATILE AMPLIFIER

(Continued from preceding page)

OTHER PARTS

- One International Transformer Co. power transformer, P.T.1;
- One International Transformer Co. output transformer, O.T.1;
- International Transformer Co. frequency-compensating network, T.C.1;
- International Transformer Co. frequency-compensating choke, Ch.1;
- One International Transformer Co. filter choke, Ch.2;
- One International Transformer Co. filter choke, Ch.3;
- One International Transformer Co. chassis;
- One International Transformer Co. floating socket plate;
- One International Transformer Co. bottom plate;
- One International Transformer Co. complete set of hardware;
- Four Hygrade Sylvania tubes; 6SJ7, 6SF5, 6L6G, 5U4G.
- Four American Phenolic sockets for tubes;
- One Littelfuse Laboratories fuse mount;
- One Littelfuse Laboratories 2-amp. fuse;
- One Drake pilot light assembly.

Please Say That You Saw It in RADIO-CRAFT

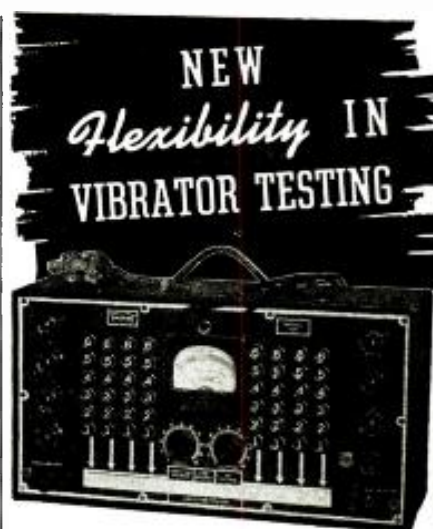

VIBRATOR TESTER

PUSH-BUTTON TYPE

Model 1671 .. \$41.67 Dealer Net

- Tests All Standard 6-Volt Vibrators
- Easy to Operate . . . Roll Chart Shows Correct Button Settings
- Uses Approved 5000 Ohms Load
- Tester Fused Against Shorted Vibrator.
- Flexible Push-Button Switching Permits Placing Proper Voltages on Each Reed, Guarding Against Possibility of Obsolescence.

Triplet Model 1671 will take the guess out of vibrator testing . . . help you locate trouble quicker . . . sell more vibrators.

This new tester has been developed with the cooperation of leading vibrator engineers, and uses the standardized 5000 ohms-8 mfd. load. It will test all standard makes of six-volt vibrators as used in automotive and home battery receivers. The Model 327-A indicating instrument has three scales: 0-10 volts to show input voltage to vibrator for start or running tests. . . . A two-zone, two-color merit scale used in conjunction with the load rheostat shows vibrator condition as GOOD or BAD. . . . A 0-100 scale permits inter-comparison of vibrator outputs under standardized input conditions. A roll chart incorporated immediately below the push-buttons reduces test settings to utmost simplicity. Tester has tip jack facilities for oscilloscope connections. Like provisions have been made for connecting external buffer condensers if desired.

Model 1671 in Standard Triplet DeLuxe Metal Case, 14 1/2 x 7 1/2 x 4 1/2 in. Black Suede Finish . . . Silver and Black Etched Panel . . . Dealer Net \$41.67

Model 1671 in Standard Triplet DeLuxe Leatherette Case With Removable Cover and Compartment for Accessories . . . Dealer Net \$45.67

Also Available . . . Model 1670 with selector switch controls. In DeLuxe Metal Case . . . Dealer Net \$24.00

SEE YOUR JOBBER OR WRITE FOR CATALOG



THE TRIPLET ELECTRICAL INSTRUMENT CO.
165 Harmon Ave., Bluffton, Ohio
Please send me more information on Model 1671;
 Model 1670.

Name

Address

City State

Model 557

SIGNAL GENERATOR

ACCURACY GUARANTEED

Complete with accessories
Dealer Price only

\$18.90

Readrite
THE RANGER

EXCLUSIVE READRITE BANDER DEVELOPMENT



Model 557 Direct Reading Signal Generator uses plug-in type coils. Five frequency bands are covered from 110 to 20,000 KC., all fundamentals. Completely shielded for static and magnetic fields. Attenuation and stability are outstanding features. Strong signals both modulated and unmodulated are furnished.

Each individual coil separately calibrated.

Accuracy Guaranteed Within All Servicing Requirements.

Write for Catalog
Section 516
COLLEGE DRIVE

READRITE METER WORKS, Bluffton, Ohio

BRUSH

BJ HEADPHONES

Communications type—lightweight, durable aluminum case—phones encased in molded rubber jackets—good ear seal.



Write for your Brush catalog today

THE BRUSH DEVELOPMENT CO.

3311 Perkins Ave. Cleveland, Ohio

FREE!

HAMMARLUND 28th YEAR RADIO CATALOG

The most complete catalog ever published with illustrations, drawings, curves and a complete description of receivers and foundation units. Write Dept. RC-5-39.

HAMMARLUND MFG. CO., INC.
424-438 West 33rd Street, New York



CHECK THE NEW LOCTAL TUBES WITH CERTAINTY!

Naald adapters are the ones you can safely buy—worked out in collaboration with instrument and tube manufacturers, they insure perfect operation over long life period.

Insist on Naald sockets in any new equipment which you purchase—use no other than Naald to bring your present equipment up to the minute.

It is an item you buy but once—get the best—correctly wired—correctly thought out—with contacts which have proven themselves superior in long life service.

Order through your jobber or write us direct.

ALDEN PRODUCTS CO., 717 Center St., Brockton, Mass.

"A Tested Plan for a Future in Radio Engineering"

Train at home in your spare time for a better radio job and more money. CREI men succeed—write for FREE illustrated BOOKLET for complete details and how we can help YOU improve your position.

CAPITOL RADIO ENGINEERING INSTITUTE
Dept. RC-5
3224-16th St., N.W., Washington, D. C.



48 NEW TUBES

7A8—TABLE III (Continued from page 687)

Operating Conditions and Characteristics

Heater voltage	6.3 volts
Plate voltage	250 volts
Control grid voltage (G)	-3.0 volts
Screen voltage (G ₂)	100 volts
Anode grid voltage (G ₁) (through 20,000 ohms)	250 volts
Oscillator Grid resistor (G ₀)	50,000 ohms
Plate current	3.0 ma.
Screen grid current	2.8 ma.
Anode grid current	4.5 ma.
Oscillator grid current	0.40 ma.
Cathode resistor	300 ohms
Plate resistance	700,000 ohms
Conversion conductance	600 micromhos
Control grid voltage for 2 micromhos conv. cond.	-30 volts

35A5—TABLE VII

Tentative Ratings and Characteristics

Heater voltage A.C. or D.C. (nominal)	35.0 volts
Heater current (nominal)	0.160 ampere

Operating Conditions and Characteristics

Heater voltage	32.0 volts
Plate voltage	110 max. volts
Screen voltage	110 max. volts
Grid voltage	-7.5 min. volts
Plate current	35 ma.
Screen current	2.8 ma.
Plate resistance	25,000 ohms
Mutual conductance	5500 micromhos
Load resistance	2500 ohms
Self bias resistor	200 ohms
Power output	1.4 watts
Total harmonic distortion	10 per cent

7C6—TABLE IV

Tentative Ratings and Characteristics

Heater voltage A.C. or D.C. (nominal)	7.0 volts
Heater current (nominal)	0.160 ampere
Direct interelectrode capacities, triode unit:	
Grid-Plate	1.4 mmf. max.
C _g -(f+k)	2.4 mmf.
C _p -(f+k)	3.0 mmf.

Operating Conditions and Characteristics

Heater voltage	6.3 volts
Plate voltage	250 max. volts
Grid resistor	10 megohms
Plate current (rating value only)	1.3 ma.
Plate resistance	0.1 megohm
Mutual conductance	1,000 micromhos
Amplification factor	100

35Z3—TABLE VIII

Tentative Ratings and Characteristics

Heater voltage A.C. or D.C. (nominal)	35.0 volts
Heater current (nominal)	0.160 ampere

Operating Conditions and Characteristics

Heater voltage*	32.0 volts
A.C. plate voltage (r.m.s.)	250 max. volts
D.C. output current	100 max. ma.
Max. peak inverse voltage allowable	700 volts
Max. peak plate current allowable	400 ma.
Tube drop at 200 ma.	22 volts

*The D.C. potential difference between heater and cathode must not exceed 300 volts.

7B7—TABLE V

Tentative Ratings and Characteristics

Heater voltage A.C. or D.C. (nominal)	7.0 volts
Heater current (nominal)	0.160 ampere
Direct interelectrode capacities:	
Grid to plate	0.005 mmf. max.
C _g -(f+k+g ₂ +g ₃)	5.0 mmf. max.
C _p -(f+k+g ₂ +g ₃)	7.0 mmf. max.

Operating Conditions and Characteristics

Heater voltage	6.3 volts
Plate voltage	250 max. volts
Screen voltage	100 max. volts
Grid voltage	-3 min. volts
Suppressor connected to cathode at socket	
Plate current	8.5 ma.
Screen current	2.0 ma.
Plate resistance	0.7 megohm
Mutual conductance	1700 micromhos
Amplification factor	1200
Grid voltage for mutual conductance of 10 micromhos	-10 volts

7B5—TABLE IX (See Below)

7B6—TABLE X

Nominal Ratings

Heater voltage (A.C. or D.C.)	7.0 volts
Heater current	0.32 amp.

Direct Interelectrode Capacities (Nominal)—Triode Section

G to P (grid to plate)	1.5 mmf.
G to K (input electrode)	3.0 mmf.
P to K (output electrode)	3.0 mmf.

Typical Amplifier—Class A Conditions—Triode Section

Heater voltage	6.3 volts
Heater current	0.3 amp.
Plate voltage	250 max. volts
Grid bias	-2 volts
Amplification factor	100
Plate resistance	91,000 ohms
Transconductance	1,100 micromhos
Plate current	1 ma.

7Y4—TABLE VI

Tentative Ratings and Characteristics

Heater voltage A.C. or D.C. (nominal)	7.0 volts
Heater current (nominal)	0.53 ampere

Operating Conditions and Characteristics

Full-Wave Rectifier

Condenser or Choke Input to Filter

Heater voltage*	6.3 volts
A.C. voltage per plate (r.m.s.)	350 max. volts
D.C. output	60 max. ma.
Max. peak inverse voltage allowable	1000 volts
Max. peak plate current allowable	250 ma.

Half-Wave Rectifier

Condenser or Choke Input to Filter (Pin. 3 and 6 tied together)

Heater voltage	6.3 volts
A.C. plate voltage (r.m.s.)	350 max. volts
D.C. output	75 max. ma.
Max. peak inverse voltage allowable	1000 volts
Tube voltage drop at 60 ma. per plate	19 volts

*The D.C. potential difference between heater and cathode must not exceed 450 volts.

7B8—TABLE XI

Nominal Ratings

Heater voltage (A.C. or D.C.)	7.0 volts
Heater current	0.32 amp.

Maximum and Minimum Ratings

Maximum plate voltage	250 volts
Maximum screen (G ₂ & G ₃) voltage	100 volts
Maximum anode-grid (G ₂) voltage	250 volts
Maximum anode-grid supply voltage	200 volts
Minimum control-grid (G ₁) bias	-3 volts
Maximum total cathode current	14 ma.

Direct Interelectrode Capacities

G ₁ to P (mixer grid to plate)	0.30 max. mmf.
G ₁ to G ₂ (mixer grid to oscillator plate)	0.20 mmf.
G ₁ to G ₃ (mixer grid to oscillator grid)	0.15 mmf.
G ₁ to G ₂ (oscillator grid to plate)	0.8 mmf.
G ₁ to all other electrodes (mixer input electrode)	9.5 mmf.
G ₂ to all other electrodes except G ₁ (osc. output electrode)	3.0 mmf.
G ₃ to all other electrodes except G ₂ (osc. input electrode)	4.4 mmf.
P to all other electrodes (mixer output electrode)	9.0 mmf.

7B5—TABLE IX

Normal Ratings

Heater voltage A.C. or D.C.	7.0 volts
Heater current	0.43 amp.
Maximum plate voltage	250 volts
Maximum screen voltage	250 volts

Typical Amplifier—Class A Conditions

Heater voltage	6.3	6.3	6.3	6.3	volts
Plate voltage	100	135	180	250	volts
Screen voltage	100	135	180	250	volts
Grid bias	-7	10	-13.5	-18*	volts
Amplification factor (approx.)	150	150	150	150	
Plate resistance (approx.)	103,500	94,000	81,000	68,000	ohms
Transconductance	1,450	1,600	1,850	2,200	micromhos
Plate current	9	12.5	18.5	32	ma.
Screen current	1.6	2.2	3	5.5	ma.
Load resistance	12,000	10,400	9,000	7,600	ohms
Total harmonic distortion	10	10	10	10	per cent
Power output	0.33	0.75	1.5	3.4	watts

*A bias of -18.5 volts and load resistance of 7,000 ohms will give power output of 3.2 watts with 7% total harmonic distortion.

Please Say That You Saw It in RADIO-CRAFT

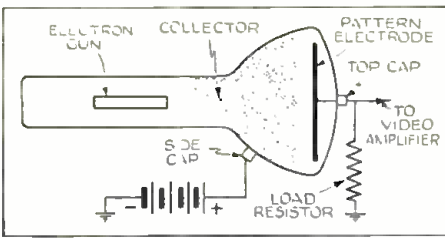

Connections of the type 2203 Monotron.

7B8—TABLE XI (Continued from opposite page)

Typical Frequency Converter Conditions		
Heater voltage	6.3	6.3 volts
Heater current	0.3	0.3 amp.
Plate voltage	100	100 volts
Screen voltage	50	100 volts
Anode-grid voltage	100	— volts
Anode-grid supply voltage	—	250* volts
Control-grid bias	-1.5 min.	-3 volts
Oscillator grid resistor	50,000	50,000 ohms
Plate resistance	0.6	0.36 megohm
Conversion trans-conductance	360	550 micromhos
Plate current	1.1	3.5 ma.
Screen current	1.3	2.7 ma.
Anode-grid current	2.0	4.0 ma.
Oscillator grid current	0.25	0.4 ma.
Control grid bias (approximate)		
For conversion trans-conductance = 6 micromhos	—	-35 volts
For conversion trans-conductance = 3 micromhos	20	volts

*Applied through a 20,000-ohm series resistor.

7C5—TABLE XII

Nominal Ratings		
Heater voltage (A.C. or D.C.)	7.0	volts
Heater current	0.48	amp.
Maximum plate voltage	250	volts
Maximum screen voltage	250	volts
Typical Amplifier—Class A Conditions		
Heater voltage	6.3	6.3 volts
Heater current	0.45	0.45 amp.
Plate voltage	180	250 volts
Screen voltage	180	250 volts
Grid bias	-8.5	-12.5 volts
Amplification factor (approximate)	210	218
Transconductance	3,500	4,100 micromhos
Max.-signal voltage (r.m.s.)	6.0	8.84
No-signal plate current	29	45 ma.
Max.-signal plate current	30	47 ma.
No-signal screen current	3	4.5 ma.
Max.-signal screen current	4	6.5 ma.
Load resistance	5,500	5,000 ohms
Total harmonic distortion	6	6 per cent
2nd-harmonic distortion	5.5	4.5 per cent
3rd-harmonic distortion	2.5	3.5 per cent
Max.-signal power output	2	4.25 watts
Typical Amplifier—Push-Pull—Class AB Conditions—Two Tubes		
Heater voltage	6.3	volts
Heater current	0.45	amp
Plate voltage	250	volts
Screen voltage	250	volts
Grid bias	-15	volts
Max.-signal voltage—grid to grid (r.m.s.)	21.2	volts
No-signal plate current	70	ma.
Max.-signal plate current	79	ma.
No-signal screen current	5	ma.
Max.-signal screen current	12	ma.
Load resistance	10,000	ohms
Total harmonic distortion	4	per cent
3rd-harmonic distortion	3.5	per cent
Max.-signal power output	8.5	watts

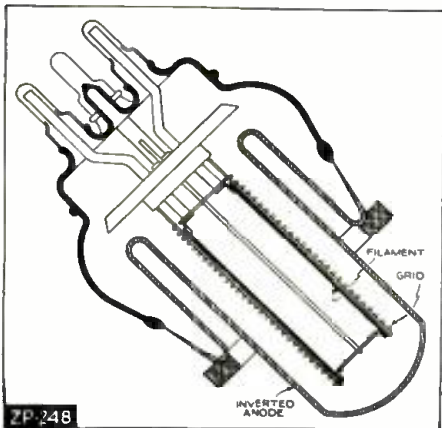

Cross-section, new high-power ultra-shortwave tube.

12A8GT—TABLE XIII

Heater voltage	12.5	volts
Heater current	.150	amp.
Operating Characteristics		
Plate voltage	100	250 volts
Screen-grid voltage	50	100 volts
Anode-grid voltage	100	250* volts
Control-grid voltage	-1.5	-3 volts
Plate current	1.2	3.3 ma.
Screen current (Grid No. 3 & No. 5)	1.5	3.2 ma.
Anode-grid current (Grid No. 2)	1.6	4.0 ma.
Oscillator grid current (Grid No. 1)	0.25	0.50 ma.
Plate resistance	0.60	0.36 megohm
Oscillator-grid resistor	50,000	50,000 ohms
Conversion conductance (Sc)	350	500 micromhos
Control-grid voltage for Sc = 2 micromhos	-20	-45 volts

*Through 20,000-ohm dropping resistor.

Direct Interelectrode Capacities

Grid No. 4 to plate	.20	mmf.
Grid No. 4 to Grid No. 2	.19	mmf.
Grid No. 4 to Grid No. 1	.13	mmf.
Grid No. 1 to Grid No. 2	1.0	mmf.
Grid No. 4 to all other electrodes	7.5	mmf.
Grid No. 2 to all other electrodes	5.0	mmf.
Plate to all other electrodes	7.5	mmf.
Grid No. 1 to all other electrodes	6.2	mmf.

*With shield on.

12F5GT—TABLE XIV

Heater voltage	12.5	volts
Heater current	.150	amp.
Operating Characteristics		
Plate voltage	100	250 volts
Control-grid voltage	0	-2 volts
Plate current	1.8	.9 ma.
Plate resistance	50,000	66,000 ohms
Transconductance	1,520	1,500 micromhos
Amplification factor	80	100
Direct Interelectrode Capacities		
Grid to plate	2.4	mmf.
Input	1.9	mmf.
Output	3.4	mmf.

12J7GT—TABLE XV

Heater voltage	12.5	volts
Heater current	.150	amp.
Operating Characteristics		
Plate voltage	100	250 volts
Screen-grid voltage	100	100 volts
Control-grid voltage	-3	-3 volts
Plate current	2.0	2.0 ma.
Screen-grid current	0.5	0.5 ma.
Plate resistance	1.0	1.5 megohm
Transconductance	1,185	1,225 micromhos
Amplification factor	1,185	1,500
Direct Interelectrode Capacities		
Grid to plate	.005	mmf. (max.)
Input	4.3	mmf.
Output	9.0	mmf.

12K7GT—TABLE XVI

Heater voltage	12.5	volts
Heater current	.150	amp.
Operating Characteristics		
Plate voltage	100	250 volts
Screen-grid voltage	100	100 volts
Control-grid voltage	-3	-3 volts
Plate current	6.5	7.0 ma.
Screen-grid current	1.6	1.7 ma.
Plate resistance	250,000	800,000 ohms
Transconductance	1,325	1,450 micromhos
Amplification factor	350	1,160
Control-grid voltage for transconductance = 2 micromhos	-38.5	-42.5 volts
Direct Interelectrode Capacities		
Grid to plate	.005	mmf. (max.)
Input	4.0	mmf.
Output	9.0	mmf.

12Q7GT—TABLE XVII

Heater voltage	12.5	volts
Heater current	.150	amp.
Operating Characteristics		
Plate voltage	100	250 volts
Control-grid voltage	0	-3 volts
Plate current	2.3	1.1 ma.
Plate resistance	43,000	58,000 ohms
Transconductance	1,400	1,200 micromhos
Amplification factor	60	70
Direct Interelectrode Capacities		
Grid to plate	1.7	mmf.
Input	1.7	mmf.
Output	3.5	mmf.

35L6GT—TABLE XVIII

Heater voltage	35.0	volts
Heater current	.150	amp.
Operating Characteristics		
Plate voltage	110	volts
Screen-grid voltage	110	volts
Control-grid voltage	-7.5	volts
Plate current (zero signal)	40	ma.
Plate current (max. signal)	41	ma.
Screen-grid current (zero signal)	3	ma.
Screen-grid current (max. signal)	7	ma.
Transconductance	5,800	micromhos
Amplification factor	80	
Signal voltage (peak)	7.5	volts
Load resistance	2,500	ohms
Power output	1.5	watts
Total harmonic distortion	6.5%	

(Continued on page 694)

Please Say That You Saw It in RADIO-CRAFT



MODERNIZE

is the word today. Restaurants, ball-rooms, schools, churches, hospitals — institutions of every kind are taking heed! The standout trend is to Public Address: — and the standout buy in Public Address is LAFAYETTE!

YOU CAN DO IT --

Sell this new streamlined P.A. Earn big money. Hundreds of restaurant owners, public officials, institution superintendents are eager to have sound re-enforcement equipment. You can sell Lafayette systems easily — prices are unusually attractive. Lafayette systems can be sold with confidence! Lafayette enjoys the benefit of 18 years' engineering experience, the facilities of the world's largest plant exclusively devoted to P.A.

YEARS-AHEAD P. A.

For 1939 Lafayette offers a line of sound systems so new, so advanced in scope and style and engineering, so packed with Tomorrow's features, that the prices you quote become purse-openers every time! With Lafayette, you have a sound system to fit every prospect's needs. For this year Lafayette — and only Lafayette — offers three complete lines of P.A.—the Lafayette Economy, Standard and DeLux ranges.

WRITE AT ONCE

for complete information and catalog. Earn big profits. Be the man to see for P.A. in your district. Remember—Lafayette is the most complete line of sound equipment in the world!

LAFAYETTE
p. a. sales division

NEW YORK • ATLANTA
CHICAGO

LAFAYETTE RADIO CORPORATION
Dept. 3EP9 100 Sixth Ave., New York, N. Y.

Yes—send me complete information on how to make more money in P.A.

Name _____ PLEASE PRINT

Address _____

City _____ State _____

ANOTHER SHANEY ACHIEVEMENT



Master Series Beam Amplifiers

Incorporate more than 42 exclusive and modern features not found in any other amplifier regardless of price. Send for free ILLUSTRATED CATALOGUE describing the only amplifier line GUARANTEED for FIVE YEARS.

Mr. A. C. Shaney and his expert engineering staff will gladly help you plan any P.A. Installation without obligation. Send details for prompt and free advice.

AMPLIFIER CO. of AMERICA

17 WEST 20th STREET NEW YORK, N. Y.

SPEAKER PLACEMENT IN PUBLIC ADDRESS WORK

(Continued from page 669)

so it could be substituted at a moment's notice.

SKATING RINK

Figure 2 shows the arrangement in an indoor skating rink in New York City. Used for both roller and ice skating, music was required both on the skating surface and in the surrounding seating area. Here again the ordinary round center cluster was ruled out by the relatively narrow dimension across as compared with the length. The 4 speakers employ wide-angle flare baffles and although aimed toward the ends of the rink their wide-angle radiation provides good overall coverage with less trouble from reverberation and echo than is usually encountered in large, bare structures of this type, in which even the skating surface constitutes a reflecting surface.

The system is used for music and announcements; with the amplifier, microphone and phono record player all enclosed in the operating room feedback did not constitute a problem.

AUDITORIUM

Figure 3 shows a somewhat conventional arrangement of speakers in an auditorium which does not include a balcony. Here the speakers are mounted on either side of the stage and tilted downward 15 degrees, their elevation being such that the rear of the audience is just brought within the area of coverage, with little if any direct sound striking the rear wall.

A similar installation where there is a balcony includes a single additional speaker mounted well above the center of the stage. In this case the elevation and radiation angle of the lower speakers is so adjusted

as to limit their area of direct coverage to the orchestra seats. The single speaker's "beam" is confined to coverage of the balcony. A single speaker serves for the balcony because, due to the relatively great distance, its beam width, even at the front of the balcony, is sufficiently great to embrace the entire area.

BANDSTAND

Figure 4 is the installation of speakers on a typical park bandstand. Here the speakers utilize wide-angle horns with flat, rectangular openings. These throw the sound out over a wide area but in a relatively shallow "layer." The result is that those close enough to the stand to hear directly, receive little of the reinforcement, its principal sound energy being reserved for the listeners who are well back from the stand. This arrangement, plus the fact that the speakers are mounted on top of the roof, protects the microphones from feedback.

RESTAURANT

In Fig. 5 two wall-type loudspeakers are employed to carry the orchestra music to the wings and beyond the dance floor of a New York restaurant. Speaker No. 1 is directed straight back and covers approximately the rear-left quarter of the total area. Speaker No. 2 is placed at an angle, directing sound away from the entrance, but covering the area not included in the range of the first speaker. Both speakers are well elevated and tilted downward to provide comfortable volume throughout the rear part of the restaurant, without discomfort to diners seated nearby.

OFFICE CALL SYSTEM

A call system in a large, open office is shown in Fig. 6. It was found that, although the area is about 10,000 sq. ft. and there is the usual continuous clatter of many typewriters, two speakers were adequate for the job. The microphone is at the switchboard as indicated at "M" and thus sufficiently out of the field of coverage of the speakers to avoid feedback. Here again the speakers are well up toward the ceiling, and tilted downward. This arrangement was made possible by the relatively high ceiling. Had the ceiling been lower, it would have been desirable to employ more speakers and operate them at a lower level to avoid discomfort to workers nearby.

These illustrations represent a variety of installations in which specific problems were solved in a manner which proved to be highly successful in every case. For the most part they were planned with a combination of old-fashioned common sense, plus experience and a thorough knowledge of the characteristics of the equipment and particularly of the various types of speaker baffles. *Knowing what type of speaker equipment to use, the volume level at which it should be operated, and the best place to put it, represent the factors that more often than anything else make the difference between a first-class sound man and the mediocre one.*

This article has been prepared from data supplied by courtesy of Wholesale Radio Service Co.

BIRDCAGE MIKES

"Birdcages" is the sobriquet WOR engineers last month tacked onto the Cardioid microphone. (See detailed article in March *Radio-Craft*.) A total of 16 of the "birdcages" join a mike line which includes the saltshaker and 8-ball types.

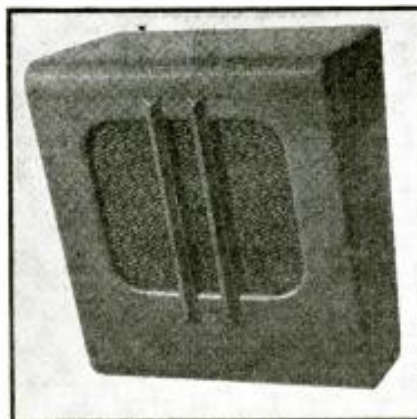

Fig. A. A representative type of tilted reproducer is illustrated above. This is a Lafayette loudspeaker with a 15-degree tilt.

Please Say That You Saw It in RADIO-CRAFT

EXTRA! BIG MONEY SAVING CATALOG
BARGAIN BULLETIN
Just off the press

Hundreds of items at New Low Prices. Radios, Sporting Goods, Jewelry, Electrical Appliances, Furniture, Luggage, Typewriters, Binoculars, Silverware, Gifts, Novelties, etc.

MAIL THIS COUPON FOR FREE CATALOG

RADIO CIRCULAR CO.
 315 Broadway, New York, N. Y.
 Rush Free Copy of BARGAIN BULLETIN. No obligation.

Name

Address

City

State

SAVE MONEY ON RADIO SETS AND PARTS

SEND FOR OUR FREE GIANT SPRING CATALOG ILLUSTRATING AND DESCRIBING OVER 1,000 MONEY SAVING ITEMS.

UNITED RADIO COMPANY
 BOX 1000 NW-NEWARK, N. J.

DX COILS
"the heart of a good receiver"

The NEW SPIDERWEB LOOP!
 replaces outside antenna. Used on thousands of latest model receivers. Made by makers of DX precision coils. Engineers, service men and custom set builders will find just the coil needed in the DX de luxe catalog. Leading jobbers have DX coils or can get them for you. Send 15c stamps for latest catalog. Mention your jobber's name. **DX RADIO PRODUCTS CO.** 1375-A Milwaukee Ave., Chicago

MAKE YOUR OWN "TALKIES"!

with MILES newly patented "FILMGRAPH"—instantaneous SOUND-ON-FILM RECORDER and REPRODUCER. No dark room nor processing required. Special models to make "TALKIES" in conjunction with cameras or SILENT as well as sound projectors. Also models for use with or without pictures. 84 minutes of recording (without pictures) may be had on 100 feet of 16 mm. film coating only 85 cents. Permanent play-back. Moderate initial cost of FILMGRAPH—only expense for putting SOUND-ON-FILM. **MILES REPRODUCER CO., 812-RC6 Broadway, New York, N. Y.**

LEE'S Correspondence Courses in RADIO and ELECTRICAL ENGINEERING

ELECTRICAL ENGINEERING Get good grasp of wide electrical field. Prepare yourself, at Low Cost, for secure future. Modern, simplified, you can understand quickly. **RADIO ENGINEERING** Extra fine course in radio, public address, photo-electric work. Train you to be super-service man, real vacuum tube technician. Expert, kits furnished. Diploma on completion. Tuition, \$25, either course. Deferred payment plan. **FREE** Get copies of school catalogs, student magazines, complete details. **SEND NOW!**

LINCOLN ENGINEERING SCHOOL, Box 931-C6, LINCOLN, NEBR.

LOOK HERE
 Send a 3c. stamp

to receive a sample paper condenser and the latest complete catalog of ILLINOIS Electrolytic and paper condensers.

Be sure you mention your jobbers name

ILLINOIS CONDENSER CO.
 1160 N. Howe Street Chicago, Illinois

AN "OCTAVE-RESONANCE" MULTIPLE AIR-COLUMN BAFFLE

(Continued from page 665)

directional characteristics found in all tests of this baffle. Complete sound distribution is obtained with the unit through an angle equivalent to 170 degrees. Construction was so engineered as to permit a converging of tones from all pipes at a point approximately 12 feet in front of the unit in operation. Through this construction all beam effects which have been so common in previously popular types of enclosures have been eliminated.

OVERLOADS

Through efficient and proper loading of the loudspeaker cone the power handling capacity is increased; and the bugaboo of burned-out voice coils is reduced to a minimum.

In the laboratory it was found that the loudspeaker would stand an overload as great as 40 per cent of its rated power handling capacity. It is not necessary to elaborate on the fact that this means so much to sound equipment especially since a lower powered amplifier and speakers

with a lower power handling capacity can be used in practically every installation where the baffle is used. This often results in enough of a cash saving to offset the original cost of the baffle!

At present, production schedules are being completed to render the unit available in both high-fidelity and standard models, both in cabinets and in chassis only, from any well-known distributors of sound equipment.

A comparison test (using a standard 8-inch dynamic speaker and a Lafayette model C-37 receiver) by *Radio-Craft* last month, between the Octave-Resonance Baffle and a 3-ft. celotex baffle, resulted in favor of the former on the bases of frequency range, volume, and distribution. Incidentally, the author states that the 8-inch speaker when used in his baffle achieves a frequency response range of 26 to 13,000 cycles!—Editor.

This article has been prepared from data supplied by courtesy of Allison Baffle Co.

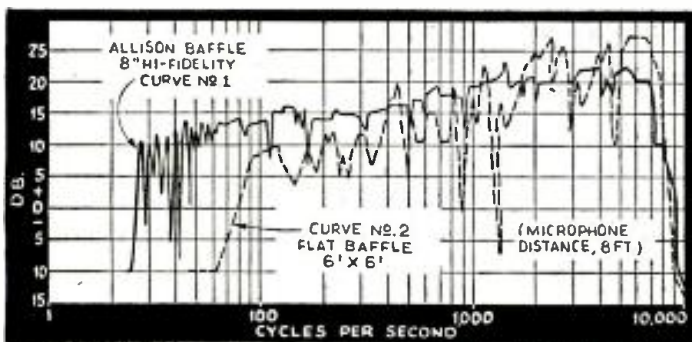

Response curves are very tricky and unreliable unless run outdoors and in still air. However, the curve at left, which compares a high-fidelity Octave-Resonance Baffle with an (approx.) equivalent Flat Baffle, clearly shows the manner in which peak-response effects are reduced and frequency-response range is extended.

NEW CIRCUITS IN MODERN RADIO RECEIVERS

(Continued from page 663)

may be compared to any oscillator tracking condenser. Finally, the entire grid circuit tuned elements consisting of 55b, 65c, 48, 65b, 63 and 45 are tuned to the signal frequency by means of adjusting pushbutton trimmers such as 55b.

(4) COMBINATION BIAS DIVIDER-LOAD

Goodyear Model 01501 Auto-Radio. By making the bias divider resistance values sufficiently high it is possible, as this circuit demonstrates, to omit the regular grid series resistor as the divider is also acting as the grid load.

In Fig. 2B we see that the grid of the 1st audio 6R7G tube is connected directly to the bias divider where two 1 meg. resistors are connected. One of them is grounded while the other is connected through a 0.25-mf. condenser which has negligible reactance compared to 1 meg-ohm at audio frequencies. Therefore, we may consider that the total grid load is ½-meg. just as though it were grounded through a ½-meg. resistor.

This condition cannot be obtained for the other bias voltages, because of lower resistance values and because of the coupling

which would result if more than one bias voltage in the same divider were obtained in this way.

(5) ELECTRON DEFLECTOR WIRING BETTERS SELECTIVITY AND A.V.C. ACTION AT HIGH VOLUME LEVELS

Airline Models 62-550, 62-1550 and 62-2550. Making a new and different use of a triode plate, the grid of which is used as a 2nd-detector diode, results in greatly reducing the load on the output I.F. circuit.

As in Fig. 2C, it will be seen that the 1H4G plate is connected directly to the A.V.C. line and hence assumes the potential of the line at all times. With increasing signal strengths the plate becomes more negative and repels the electrons flowing to the grid. This raises the impedance of the grid input circuit so that the I.F. voltage peaks at the 2nd I.F. output—can rise to higher values and within narrower frequency limits. In other words, by reducing the load on the I.F. transformer we have increased its effective "Q". However, enough electrons can pass to form the A.V.C. voltage and the return circuit can be higher than usual in resistance for the same A.V.C. voltage.

"STATIC" IN CRYPT OF KNOWLEDGE!

A sound film demonstrating artificial lightning produced by the 10,000,000-volt generator in the Pittsfield, Mass., plant of the General Electric Company will be

sealed in the air-tight Oglethorpe University Crypt of Knowledge. There it will remain, inviolate, until 8113 (6,000 years hence).

Please Say That You Saw It in RADIO-CRAFT

BUILD YOUR OWN FACSIMILE RADIO PRINTER



CROSLY READO KIT \$49.50

GET IN ON THE GROUND FLOOR WITH RADIO'S MOST PROMISING DEVELOPMENT

Already daily broadcasting experiments from leading radio stations offer fascinating study and fun. This new art holds promise of a great future, and

another chance to grow up in a field as prolific of personal profit and satisfaction as radio was 20 years ago. Time is not far distant when radio facsimile printers may constantly deliver into American homes an exciting stream of pictures of events as they happen together with visual reports, vital information and news. Already the progress provides much of interest and for study in the early morning broadcasts of news and pictures with many stations operating on ultra high frequency during daylight hours.

The Crosley "Reado" radio printer is a development of the Finch method and is being used in many spots throughout the country today. When you have built the printer it is easily attached to your own radio receiver. We provide all the necessary parts carefully precision machined ready to build, packed in a special kit. Most Crosley dealers will display them. If none are convenient to you, write us.

THE CROSLY CORPORATION
READO DEPARTMENT POWEL CROSLY, Jr., Pres.
104 ARLINGTON STREET CINCINNATI, OHIO

Please send me literature about the Crosley READO, all facsimile broadcasting activities and list of stations now doing experimental broadcasting. Also, the name of my nearest Crosley dealer to carry the Reado Kit.

USE THIS COUPON

NAME.....

ADDRESS.....

GET A REAL ELECTROPLATING KIT ABSOLUTELY FREE! Complete details as to how it is possible to get a real electroplating kit FREE, appears on Page 699 of this issue.

Catalog upon request
SOLAR MFG. CORP., 599 Broadway, New York

FREE TRIAL OFFER

NEW REMINGTON NOISELESS PORTABLE!



AS LITTLE AS
10¢ A DAY

Famous Remington Noiseless Portable that speaks in a whisper. Pay as little as 10¢ a day. Guaranteed by the factory. Standard keyboard. Automatic ribbon reverse. Variable line space and all the conveniences of the finest portable ever built. PLUS the NOISELESS feature. Act now. Send coupon TODAY for details.

You don't RISK a Penny

We send you Remington Noiseless Portable for 10 days' free trial. If not satisfied, send it back. We pay all shipping charges.

Typing Course and Carrying Case

You will receive FREE a complete simplified home course in Touch Typing, a handsome sturdy carrying case is included. No obligation. Mail coupon for full details—NOW.

Remington Rand, Inc., Dept. 189-5,
465 Washington St., Buffalo, N. Y.

Tell me, without obligation, how to get a Free Trial of a new Remington Noiseless Portable, including Carrying Case and Free Typing Course for as little as 10¢ a day. Send Catalogue.

Name
Address
City State

MICHIGAN AVENUE



• The pulse of the city — Michigan Avenue.

Chicago works and plays to the tune of its rhythmic hum. In the most convenient location on this famous thoroughfare, Hotel Auditorium provides spacious pleasant rooms, excellent service and superb cuisine, at reasonable rates.

WITH BATH FROM \$2.50 WITHOUT BATH FROM \$1.50



AUDITORIUM

MICHIGAN AT CONGRESS GEO. H. MINK, *Manager*

WE HAVE The RADIO YOU WANT

Our 1939 catalog is chock full of new Standard Brand Radios for Home-Farm-Auto. Over 400 models. Also hundreds of Electric Appliances for the home. Celebrating our 50th Anniversary with Big Bargains. Write for your copy today. It's FREE.

MODELL'S Dept. 57 Cortlandt St., N.Y.C.

48 NEW TUBES

(Continued from page 691)

35Z4GT—TABLE XIX

Heater voltage	35.0	volts
Heater current	.150	amp.
Operating Characteristics		
A.C. plate voltage ¹ (r.m.s.)	125	volts (max.)
A.C. plate voltage ² (r.m.s.)	250	volts (max.)
Peak plate current (max.)	600	ma.
D.C. output current (max.)	100	ma.
Voltage drop at 200 ma. D.C.	15	volts

¹Without series resistor.
²With 100-ohm series resistor.

2Y2—TABLE XX

Heater voltage	2.5	volts
Heater current	1.75	amp.
Operating Conditions*		
A.C. plate voltage (r.m.s.)	4,400	(max.)
Peak inverse voltage	12,000	(max.)
D.C. output current (max.)	5.0	ma.

*May be used in either choke or condenser input circuit but in the latter case the input condenser should be limited to 0.5- μ f. (max.)

5X3—TABLE XXI

Filament voltage	5.0	volts
Filament current	2.0	amp.
Operating Conditions*		
A.C. voltage (r.m.s.) per plate	1,275	(max.)
Peak inverse voltage	3,600	(max.)
D.C. output current (max.)	30	ma.

Low-Voltage Operating Conditions*

A.C. voltage (r.m.s.) per plate	400	volts
D.C. output current (max.)	110	ma.

*May be used in either choke or condenser input circuits.

6AD5G—TABLE XXII

Heater voltage	6.3	volts
Heater current	0.3	amp.
Plate voltage	1,500	(max.)*
Cathode resistor	500	ohms (min.)

Low-Voltage Characteristics

Plate voltage	250	volts
Grid voltage	-2	volts
Plate current	0.9	ma.
Plate resistance	65,000	ohms
Transconductance	1,500	micromhos
Amplification factor	100	

Direct Interelectrode Capacities

Grid to plate	3.3	mmf.
Input	4.1	mmf.
Output	3.9	mmf.

*This is the plate supply voltage. The voltage effective at the plate will be this voltage minus the drop in the series resistor which should not be less than 0.2-meg.

6R6G—TABLE XXIII

Heater voltage	6.3	volts
Heater current	0.3	amp.
Plate voltage	1,500	(max.)*
Screen-grid voltage	75	(max.)
Control-grid voltage	**	

Low-Voltage Characteristics

Plate voltage	250	volts
Screen-grid voltage	100	volts
Control-grid voltage	-3	volts
Plate current	7.0	ma.
Screen-grid current	1.7	ma.
Plate resistance	800,000	ohms
Transconductance	1,450	micromhos
Amplification factor	1,160	
Transconductance = 2 when control-grid voltage =	-42.5	volts

Direct Interelectrode Capacities

Grid to plate	.007	mmf. (max.)
Input	4.5	mmf.
Output	11.0	mmf.

*This is the plate supply voltage. The voltage effective at the plate will be this voltage minus the drop in the series resistor which should not be less than 0.1-meg.
**When the grid bias is developed in the grid circuit the tube should not be operated without grid excitation. When the bias is developed in the cathode circuit the minimum value of cathode resistor should be 500 ohms.

906-P4—TABLE XXIV

Tentative Characteristics and Ratings

Heater voltage (A.C. or D.C.)	2.5	volts
Heater current	2.1	amp.
Fluorescent screen:		
Material	phosphor No. 4	
Color of fluorescence	white	
Direct interelectrode capacities:		
Control electrode (grid) to all other electrodes	9	max. mmf.
Deflecting plate D ₁ to all other electrodes	8.5	max. mmf.
Deflecting plate D ₂ to all other electrodes	6.5	max. mmf.

Maximum Ratings and Typical Operating Conditions

High-voltage electrode (anode No. 2) voltage	1,500	max. volts
Focusing electrode (anode No. 1) voltage	1,000	max. volts
Control electrode (grid) voltage		never positive
Peak voltage between high-voltage electrode and any deflecting plate	600	max. volts
Fluorescent screen input power per sq. cm.	10	max. milliwatts
Typical operation:		
Heater voltage	2.5	2.5
Heater current	2.5	2.5

Anode No. 2 voltage	600	800	1200	1500	volts
Anode No. 1 voltage (approx.)*	170	230	345	475	volts
Grid voltage**	adjusted to give suitable luminous spot				
Deflection sensitivity:					
Plates D ₁ and D ₂	0.55	0.41	0.27	0.22	mm/volt D.C.
Plates D ₂ and D ₃	0.58	0.44	0.29	0.23	mm/volt D.C.

*Adjustable to 20%.
**Approximately 20% of anode No. 1 voltage is required for current cut-off.

1802-P1 & 1802-P4—TABLE XXV

Tentative Characteristics and Ratings

Heater voltage (A.C. or D.C.)	6.3	volts
Heater current	0.6	amp.
Fluorescent screen:		
Material (1802-P1)	phosphor No. 1	
Material (1802-P4)	phosphor No. 4	
Pattern color (1802-P1)	greenish	
Pattern color (1802-P4)	white	
Direct interelectrode capacities:		
Control electrode to all other electrodes	9	mmf.
Deflecting plate D ₁ to deflecting plate D ₂	1.2	mmf.
Deflecting plate D ₂ to deflecting plate D ₁	0.8	mmf.
Deflecting plate D ₁ to all other electrodes	14	mmf.
Deflecting plate D ₂ to all other electrodes	8.5	mmf.
Deflecting plate D ₃ to all others except D ₂	13	mmf.
Deflecting plate D ₂ to all others except D ₁	12	mmf.
Deflecting plate D ₂ to all others except D ₁	8	mmf.
Deflecting plate D ₁ to all others except D ₂	7	mmf.

Maximum Ratings and Typical Operating Conditions

High-voltage electrode (anode No. 2) voltage	2,000	max. volts
Focusing electrode (anode No. 1) voltage	500	max. volts
Control electrode (grid) voltage		never positive
Grid voltage for current cut-off*	-70	approx. volts
Peak voltage between anode No. 2 and any deflecting plate	500	max. volts
Fluorescent screen input power per sq. cm.	10	max. milliwatts

Typical operation:

Heater voltage	6.3	6.3	6.3	volts
Anode No. 2 voltage	1,200	1,500	2,000	volts
Anode No. 1 voltage (approx.)	250	310	425	volts
Grid voltage	adjusted to give suitable luminous spot			

*With maximum voltage applied to Anode No. 1 and Anode No. 2.

1899—TABLE XXVI

Tentative Characteristics and Ratings

Heater voltage (A.C. or D.C.)	2.5	volts
Heater current	2.1	amp.
Direct interelectrode capacities:		
Pattern electrode to collector (without external shielding)	6	approx. mmf.
Pattern dimensions	2 1/4	ins. h. x 3 1/16
Overall length	13 3/4	ins. (approx.)

Maximum Ratings and Typical Operating Conditions

Pattern electrode voltage	1,700	max. volts
Collector voltage	1,700	max. volts
Focusing electrode No. 2 (anode No. 2) voltage	1,500	max. volts
Focusing electrode No. 1 (anode No. 1) voltage	750	max. volts
Control electrode (grid) voltage		never positive
Grid voltage for current cut-off	-60	max. volts
Typical operation:		
Heater voltage	2.5	2.5
Heater current	2.5	2.5
Pattern electrode voltage	1,000	1,500
Collector voltage	1,050	1,700
Anode No. 2 voltage	1,000	1,500
Anode No. 1 voltage	260	390
Grid voltage	adjusted to give suitable resolution and signal amplitude.	

Please Say That You Saw It in RADIO-CRAFT

Internal resistance between collector and pattern electrode greater than 1 megohm
 Beam current* 2 4 approx. microamperes
 Pattern electrode signal current peak-to-peak value 1.5 2.5 approx. microamperes
 Beam resolution capability** 500 500 lines
 *Determined by measurement of current to collector with pattern electrode terminal disconnected.
 **With full scanning.

1803-P4—TABLE XXVII

Tentative Characteristics and Ratings

Heater voltage (A.C. or D.C.) 2.5 volts
 Heater current 2.1 amp.
 Fluorescent screen material: phosphor No. 4
 Color of fluorescence white
 Direct interelectrode capacity: Grid No. 1 to all other electrodes 12 max. mmf.

Maximum Ratings and Typical Operating Conditions

High-voltage electrode (anode No. 2) voltage 7,000 max. volts
 Focusing electrode (anode No. 1) voltage 1,900 max. volts
 Accelerating electrode (grid No. 2) voltage 250 max. volts
 Control electrode (grid No. 1) voltage never positive
 Fluorescent-screen input power per sq. cm. 10 max. milliwatts
Typical operation:
 Anode No. 2 voltage 6,000 7,000 volts
 Anode No. 1 voltage (approx.)* 1,240 1,460 volts
 Grid No. 2 voltage 250 250 volts
 Grid No. 1 voltage† adjusted to give suitable luminous spot
 Grid No. 1 signal-swing voltage (approx.)** 25 25 volts

*Adjustable to ± 20%.
 †Approximately 30% of Grid No. 2 voltage is required for current cut-off.
 **Peak-to-peak value for optimum contrast.

1804-P4—TABLE XXVIII

Tentative Characteristics and Ratings

(Same as for type 1803-P4, above, which see.)
Maximum Ratings and Typical Operating Conditions
 †Except for indicated voltages of Anode No. 1, at Anode No. 2 voltages shown below, all characteristics are identical with type 1803-P4 (see above).
Typical operation:
 Anode No. 2 voltage 6,000 7,000 volts
 Anode No. 1 voltage (approx.)* 1,225 1,425 volts
 *Adjustable to ± 20%.

2V3G—TABLE XXIX

Tentative Ratings

Filament voltage (A.C.) 2.5 volts
 Filament current 5 amp.
 Peak inverse voltage 16,500 max. volts
 Peak plate current 12 max. ma.
 Average plate current 2 max. ma.

2203—TABLE XXX

Tentative Characteristics and Ratings

Heater voltage—A.C. or D.C. 2.5 volts
 Heater current 2.1 amp.
 Overall length 12 ins.
 Direct interelectrode capacities: Grid to all other electrodes 12 mmf. max.
 High-voltage anode No. 2 1,000 volts max.
 Focusing electrode Anode No. 1 (adjust for sharpest focus) 400 volts max.
 Grid voltage for cut-off -20 volts approx.
 Signal plate voltage -150 volts max.
 Signal plate input power 5 MW/sq. cm. max.
 Signal output 0.1 volts
 Deflection sensitivity 800 volts 1,000 volts
 D₁ & D₂ .34 .27 mm/v
 D₃ & D₄ .37 .30 mm/v

Typical Operation: Heater voltage, 2.5 volts; Anode No. 2 voltage, 900 volts; Anode No. 1 voltage, 285 volts; Grid voltage—adjust to give desired output; Signal plate voltage -70.

957, 958, 959—TABLE XXXI

Tentative Ratings and Characteristics

	957	958	959
Filament voltage (D.C.)	1.25	1.25	1.25
Filament current	0.05	0.10	0.05
Plate voltage	135 max.	135 max.	135 max.
Suppressor	—	—	—
Screen voltage	—	—	67.5 max.
Grid voltage	-5	-7.5	-8
Plate current	2	3	1.7
Screen current	—	—	0.4

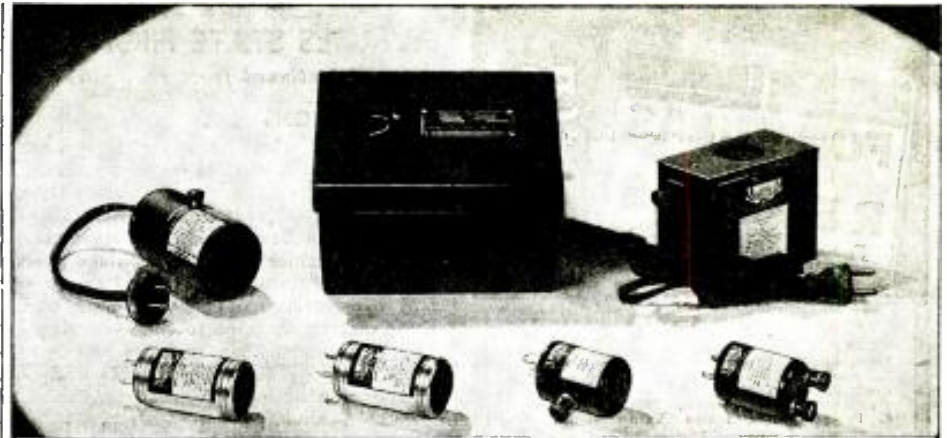

Extra Money In Your Pocket! C-D Quietone
 The Laboratory Proved Radio Interference Filters

Like all C-D products—Quietone Radio Interference Filters were checked and tested under exaggerated laboratory simulated operating conditions—before being introduced to the industry. That's why we can say with confidence—"They Actually Work!"

Here's a really fine opportunity to make extra money. C-D Quietones are scientifically designed to do a job—attractively finished and supplied in three colors to match room interiors. With a Quietone designed for every application—and there are twelve types available now—they're really a cinch to sell. Demonstrate them to your customer when you are on a call—show them—they'll sell themselves.

For complete details on these and other Quietone units see your local C-D distributor or write for Cat. 166A.

Product of the world's largest manufacturer of capacitors

Type IF4—For use with midget sets.	List Price	\$1.00
Type IF5—For use with all types of electric razors and small appliances.	List Price	\$1.00
Type IF6—For use with all types of electrical appliances.	List Price	\$1.50
Type IF7—For use with oil burners.	List Price	\$7.50
Type IF8—For use with all type receivers and electrical appliances.	List Price	\$4.95
Type IF9—For use with all larger household and office appliances.	List Price	\$5.50
Type AF10—Antenna Eliminator for all classes of radios.	List Price	\$1.00



CORNELL-DUBILIER
 ELECTRIC CORPORATION

1014 Hamilton Boulevard, South Plainfield, New Jersey

Cable Address: "CORDU"

	24,600	10,000	800,000
Plate resistance (approx.)	24,600	10,000	800,000
Amplification factor	16	12	480
Transconductance	650	1,200	600

micromhos
 *Connected to minus filament at mounting.
 †Maximum resistance in the grid circuit should not exceed 0.5-megohm.

810—TABLE XXXII

Tentative Characteristics and Ratings

Filament voltage (A.C. or D.C.) 10.0 volts
 Filament current 4.5 amp.
 Amplification factor 35
 Direct interelectrode capacities: Grid-plate 4.8 mmf.
 Grid-filament 8.7 mmf.
 Plate-filament 12 mmf.

RM-201—TABLE XXXIII

Filament 2.5 volts
 Anode current 3.5 amp.
 0.100 amp. avg.
 0.500 amp. peak
 Load time constant 15 sec.
 Max. anode volts 350 forward
 350 inverse
 Voltage drop 16 volts
 De-ionization time 1,000 micro-seconds

RM-208—TABLE XXXIV

Ratings and Characteristics

Filament voltage 2.5 volts
 Filament current 5 amp.
 Max. anode voltage (instantaneous) 2,500 volts
 Forward and Inverse
 Maximum anode current 2,500 volts
 Peak 2.0 amp.
 Average 2.0 amp.
 Max. averaging time 15 sec.
 Tube voltage drop 11 volts
 Temperature limits 35°-60°C (condensed-Hg temp.)

RM-209—TABLE XXXV

Ratings and Characteristics

Filament voltage 5 volts
 Filament current 10 amp.
 Maximum anode voltage (instantaneous) 2,500 volts
 Forward and Inverse
 Maximum anode current 2,500 volts
 Peak 12.0 amp.
 Average 2.0 amp.
 Maximum averaging time 15 sec.
 Tube voltage drop (approx.) 10 volts
 Temperature limits 35°-60°C (condensed-Hg temp.)

(Continued on page 697)

Size of box: (2 1/2" x 8 1/2")



\$2.75

Shipping Wt. 3 lbs.

VOGUE
 Pyro
 Pantagraph

With this PYRO PANTAGRAPH turn leisure time into profitable hours. Make money a novel, easy way—"Burn Your Way to Extra Dollars with Pyro Pantagraph." This electrical outfit is especially designed for burning designs permanently on Leather, Wood, Cork, Gourds, Bakelite, etc. Simply plug the Pyro-electric pencil in any 110-volt AC or DC outlet and it is ready to be used. Plug and cord furnished as part of equipment.

By the use of a special Pantagraph included in the outfit, any design may be reproduced either in original, reduced or enlarged form. Outfit consists of: one Pyro-electric Pencil; one Pantagraph; three hardwood plaques; one bottle of Varnish; one Brush; one tracing tip and four-page instruction sheet.

Outfit will be forwarded by Express Collect if not sufficient postage included with your order.

WELLWORTH TRADING COMPANY
 558 W. WASHINGTON BLVD., Dept. RC-539, Chicago, Ill.

Please Say That You Saw It in RADIO-CRAFT

Radio Men Find This Book Handy

FORMULAS AND RECIPES
For the Practical Man

50¢
POSTPAID

Here Is the Contents of the Book

1. Adhesives: Glues, Cements, Gums, Mucilages, Lubricants, 2. Cleansing: Stain Removers, Trim Removers, Bleaches, Cleaning Fluids 3. Metal Craft: Coloring, Oxidizing, Plating, Repairing, Welding, Polishes, Alloys, Solders, Amalgams 4. Paints: Colors, Stains, Varnishes, Enamels, Luminous Paint, Washable Paint, Paint Removing, Waterproofing, Fireproofing 5. Glass Working: Cutting, Drilling, Boring, Bending, Blowing, Etching, Engraving, Frosting, Silvering, etc. 6. Wood-craft: Fillers, Fireproofing, Acid-proofing, Waterproofing, Furniture Polishes, Finishes, etc. 7. Inks: Recipes, Eradicators, Ink Stain Removers, Special Inks, Colored, Indelible, Sympathetic, Invisible, Hectograph 8. Photography: Developers, Emulsions, Fixers, Sensitizing, Toning, Printing, Photographic Paper, Blueprint Paper 9. Antidotes for Poisons, Remedies for Burns and Scalds, Disinfectants, First-Aid in Accidents, Emergency Remedies, Home Remedies, 10. Preparation, Manipulation, Handling, Mixing, Measuring, Weighing, Filtering, Straining Solutions; List of Technical Substances; Emulsifying; Use of Hydrometer, Use of Thermometer; Tables of Weights and Measures, Decimal Systems, Useful Tables.

TECHNIFAX, Division RC-539
560 W. Washington Blvd., Chicago, Illinois

TECHNIFAX, Division RC-539
560 W. Washington Blvd., Chicago, Illinois

Gentlemen: Enclosed please find 50¢ (check, money order, coin or unused U.S. stamps accepted) for which send me POSTAGE PREPAID. One copy of FORMULAS AND RECIPES for the Practical Man.

Name

Address

City

State

EVERYTHING IN RADIO!

A COMPLETE SOURCE FOR YOUR RADIO NEEDS

Our immense stock of radio sets, parts and supplies enables you to purchase your entire needs on one order. You will find all your Nationally Known Favorites in this big book which is FREE for the asking. Practically every order is shipped the same day it is received.

WRITE FOR BIG NEW CATALOG

BURSTEIN-APPLEBEE CO.
1012-14 McGee St., Kansas City, Mo.

WEBSTER-RACINE

High Impedance magnetic pickup head. One of the finest pickup units made. Head only, Sh. \$1.69
Wt. 1 lb.

Webster-Racine arm to fit head Sh. \$1.29
Unit complete Sh. Wt. 1 lbs. \$2.98

Send Cash or Money Order, add Postage. Send for our 32 page Bargain Catalog. WE SAVE YOU MONEY

ARROW SALES COMPANY
619 W. RANDOLPH ST. CHICAGO, ILLINOIS

R.M.S. MEMBERS and SERVICEMEN

Sell your customers R. M. S. SUPER COMPACTS (5 tubes). Attractive Prices—Good Discounts. Exclusive Radios for the Serviceman. Write for details.

Send 10c for Philco Parts Catalog

WILLIAMS PHILCO CO.

802 S. ADAMS ST. PEORIA, ILL.

RADIO ENGINEERING

RCA Institutes offer an intensive course of high standard embracing all phases of Radio and Television. Practical training with modern equipment at New York and Chicago schools. Also specialized courses and Home Study Courses under "No obligation" plan. Catalog Dept. RT-39.

RCA INSTITUTES, Inc.

A Radio Corporation of America Service
75 Varick St., New York 1154 Merchandise Mart, Chicago

PATENTS—TRADE MARKS

Booklet concerning Inventions & Patents

Form "Evidence of Conception" with instructions for use and "Schedule of Government and Attorney Fees"—Free

LANCASTER, ALLWINE & ROMMEL

Registered Patent Attorneys

436 Bowen Bldg. Washington, D. C.

EMERGENCY NETWORK PATROLS STATE HIGHWAYS!

(Continued from page 651)

FIXED STATIONS

The fixed stations operate dependably over most of the state when required but ordinarily form communication links between the headquarters station at Olympia and district offices which, in turn, communicate with mobile and outlying fixed units in their particular territories. Hourly calls and information are broadcast from each of these district stations to their outlying stations and cars. This includes weather reports, highway condition reports and other information of local importance.

The communication system provides government offices with daily weather and flying condition reports as received from outlying stations where no established government observation is available. Cooperation is also maintained with the U. S. Park and U. S. Forest Service for emergency communication, which includes forest fire control and highway condition reports.

Many transportation systems, including bus and highway freight lines, maintain receivers on our 2,490 kilocycle frequency to receive information regarding highway and weather conditions as broadcast by our district stations. Police information broadcasts aid in the interception of criminals and stolen property as well as missing persons and cars or trucks.

This state operates a total of 51 radio stations as shown below, 25 of these being fixed stations, 21 mobile on snow plows and

"This Home—WIRED FOR RADIO."

Due to continued inclement weather the completion of the Radio Home has been delayed. Therefore it has been necessary to hold over Part IV (Conclusion); look for it in June Radio-Craft.

patrol cars, 3 on patrol boats and 2 on planes. Other units are planned and under construction at this time.

RADIO STATIONS (2,490 KC.)

STATE OF WASHINGTON, DEPARTMENT OF HIGHWAYS

Sta. No.	Call	Location	Power (Watts)
1	KGHA	Snoigo A-232 Snoqualmie	10
2	KGHB	Snoigo A-241 Snoqualmie	10
3	KGHC	A-217 Snoqualmie	10
4	KGHD	*Seattle	160
5	KGHE	*Summit	160
6	KGHF	Crystal Creek	10
7	KGHR	Snoigo A-78 Snoqualmie	10
8	KNFC	Patrol Boat "Stevens"	50
9	KNFD	Patrol Boat "Rogers"	50
10	KNFG	*OLYMPIA	250
11	KNFK	*Bellingham	160
12	KNFL	Shukson	10
13	KNFQ	Skykomish	10
14	KNFR	Snoigo A-248 Chincok	10
15	KNFS	Chehalis	10
16	KNFT	Snoigo B-292 Blewett	10
17	KNFU	Snoigo A-227 Mt. Baker	10
18	KNFV	Snoigo E-28 Snoqualmie	10
19	KNFW	Snoigo E-800 Easton	10
20	KNFX	Ellensburg	10
21	KNFY	Bear River	10
22	KNFZ	Hell's Crossing	10
23	KNGA	Goldendale	10
24	KNGB	*Yakima	160
25	KNGC	*Vancouver	160
26	KNGD	Walla Walla	50
27	KNQG	*Wenatchee	50
28	KNGR	*Spokane	250
29	KNGZ	Ephrata	10
30	KNHA	Patrol Boat "Ferry"	50
31	KACB	Okanogan	10
32	KACG	Snoigo G-727 Davenport	10
33	KACH	Glenoma	10
34	KACQ	Kalalock	10
35	KACW	Service Patrol Car H-24	10
36	KADU	Plane N.S. 665 K	10
—	KHAYW	" " (3,105 kc.)	10
37	KASH	State Car A-13	50
38	KSPW	State Patrol Car No. 300	50
39	KSPM	Snoigo B-408 Wenatchee	50
40	KSPN	Snoigo B-90 Wenatchee	50
41	KWSA	State Patrol Car 40	5
42	KWSB	Snoigo G-40 Spokane	50
43	KWSD	Snoigo D-185 Vancouver	50
44	KWSE	Raymond	50
45	KWSF	Davenport	10
46	KAXV	State Car H-24	50
47	KBIE	State Plane NC-14820	50
48	Colfax	50
49	Colville	50
50	Ritzville	50
51	Pasco	100

* Have C.W. on 2,044 kc., 2,804 kc., 2,808 kc., 5,140 kc.

A MODERN ROD ANTENNA

(Continued from page 674)

base of the antenna, and a wire run to the nearest ground available. The sewer vent can usually be used as a ground.

Similarly, an iron-core coupler at the radio set end of the lead-in is enclosed in porcelain. A weatherproof twisted-pair should be used as a lead-in connection between the transformer and the coupler. Up to 12 radio sets, each with its own coupler, can be operated from the verti-flex antenna. For minimum noise pick-up this coupler should be mounted as close as possible to the radio receiver.

Two types of mountings are available, for attaching to the sidewall, and for a level surface. (See insets in Fig. A.) Instead of ordinary bolts, Ackerman Johnson expansion plugs, the same as used by Western Union, are supplied with the sidewall brackets for mounting on a brick wall. (The sidewall bracket shown was the same one used in making tests on the verti-flex antennas.)

This new rod antenna is available in two lengths, one for 20 meters and one for 10 meters. The larger size is adjustable from 30 feet to 34 feet, and the 10-meter antenna from 15 feet to 19 feet. Both sizes can also be used on 5 meters. The 34-foot pole weighs only 5½ pounds.

This article has been prepared from data supplied by courtesy of Illinois Seating Corp. (Verti-Flex Division).

COMPLETE STEP-BY-STEP DYNAMIC SERVICING

(Continued from page 662)

on the defects causing them are shown in Figs. 10E, F and G.

STAGE-BY-STAGE TESTING

When distortion is noted, connect in succession the VERT. binding posts of the oscilloscope to the plate circuits preceding the output tube, to track down the offending stage.

ADJACENT-CHANNEL FILTER

Many high-grade receivers employ an adjacent-channel filter to eliminate interference from the audio beat note caused by the carrier of a station on the channel adjacent to that of the station being tuned-in. To be effective this filter must be tuned to exactly 10,000 cycles.

To check, make all connections just as described above under "Connections". Turn the HORIZONTAL amplifier control to "0". Set the audio generator to 10,000 cycles. The trace on the screen will be a vertical line which should be reduced to a minimum by tuning the trimmer of the adjacent-channel filter.

This article has been prepared from data supplied by courtesy of Clough-Bregle Co.

RADIO-CRAFT for MAY,
48 NEW TUBES
(Continued from page 667)

6A8GT—²⁵⁰ volts
Heater voltage (A.C.)
Heater current J
Plate voltage 0500
Screen 3
Suppressor
\$0.000
0.36
500

(approx.)	-20	-35	volts
Plate current	1.2	3.3	ma.
Screen current	1.5	3.2	ma.
Anode-grid current	1.6	4.0	ma.
Oscillator-grid current	0.25	0.5	ma.

*In circuits where the cathode is not directly connected to the heater, the potential difference between heater and cathode should be kept as low as possible.

**Anode-grid supply voltages in excess of 200 volts require the use of 20,000-ohm voltage-dropping resistors bypassed by 0.1-mf. condenser.

†This is an anode-grid supply voltage applied through 20,000 ohm voltage-dropping resistor.

6K7GT—TABLE XXXVII

Heater voltage (A.C. or D.C.) 6.3 volts
Heater current 0.3 amp.

Amplifier—Class A

Operating Conditions and Characteristics

Plate voltage	250 max.	250	max. volts
Screen voltage	100	125	max. volts
Grid voltage	-3 min.	-3	min. volts
Suppressor	connected to cathode at socket		
Plate current	7	10.5	ma.
Screen current	1.7	2.6	ma.
Amplification factor	1,160	990	
Plate resistance	0.8	0.6	megohm
Transconductance	1,450	1,650	micromhos
Grid voltage for transconductance = 2 micromhos	-42.5	-52.5	volts

6Q7GT—TABLE XXXVIII

Heater voltage (A.C. or D.C.)* 6.3 volts
Heater current 0.3 amp.

Triode Unit—Class A Amplifier

Operating Conditions and Characteristics

Plate voltage	100	250	max. volts
Grid voltage	-1.5	-3	volts
Amplification factor	70	70	
Plate resistance	87,500	58,000	ohms
Transconductance	800	1,200	micromhos
Plate current	0.35	1.1	ma.

*In circuits where the cathode is not directly connected to the heater, the potential difference between heater and cathode should be kept as low as possible.

Diode Units—Two

The 2 diode units are placed around a cathode, the sleeve of which is common to the triode unit. Each diode has its own base pin. Diode biasing of the triode unit is not suitable.

25L6GT—TABLE XXXIX

Heater voltage (A.C. or D.C.)* 25 volts
Heater current 0.3 amp.

Single-Tube Amplifier—Class A

Operating Conditions and Characteristics

Plate and screen voltage	110	110	max. volts
Grid voltage**	-7.5	-7.5	volts
Peak A.F. grid voltage	7.5	7.5	volts
Amplification factor	82	82	
Plate resistance (approx.)	10,000	10,000	ohms
Transconductance	8,200	8,200	micromhos
Zero—signal plate current	49	49	ma.
Max.—signal plate current	54	50	ma.
Zero—signal screen current	4	4	ma.
Max.—signal screen current	9	11	ma.
Load resistance	1,500	2,000	ohms
Distortion:			
Total harmonic	11	10	per cent
Second harmonic	10	3.5	per cent
Third harmonic	4	8.5	per cent
Power output	2.1	2.2	watts

*Heater to cathode bias should not exceed 90 volts D.C.

Sure you can own a RIDER CHANALYST!

NATIONAL UNION WILL GIVE YOU ONE IF YOU BUY 80 N. U. TUBES AND/OR ELECTRO CONDENSERS PER MONTH

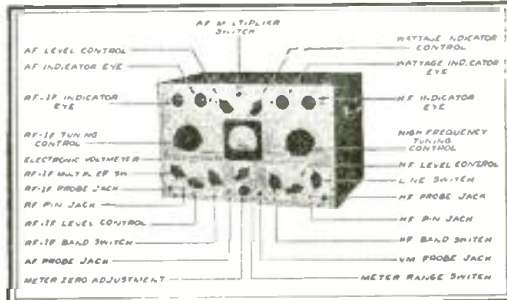

ASK YOUR NATIONAL UNION JOBBER HOW TO GET A CHANALYST FREE

The CHANALYST is a great piece of modern high efficiency test equipment . . . an invaluable asset to your service business. It is guaranteed by John F. Rider and approved by National Union Engineers. Now YOU can own one.

NATIONAL UNION RADIO CORP.
Newark, New Jersey
Who is nearest Nat. Union Jobber?

Name _____
Street _____
City _____ State _____ RC-539

Come on!

BUILD CUSTOMER CONFIDENCE WITH NATIONAL UNION TUBES and CONDENSERS!

as measured between the negative heater terminal and cathode.

**The type of input coupling used should not introduce too much resistance in the grid circuit. Transformer or impedance coupling devices are recommended. When the grid circuit has a resistance not higher than 0.1 megohm, fixed bias may be used; for higher values, self-bias is required. With self-bias, the grid circuit may have a resistance not to exceed 0.5-megohm, provided the heater voltage is not allowed to rise more than 10% above the rated value under any condition of operation.

25Z6GT—TABLE XL

Heater voltage (A.C. or D.C.) 25 volts
Heater current 0.3 amp.

Voltage Doubler and Half-Wave Rectifier*

Operating conditions:
A.C. voltage per plate (r.m.s.) 125 max. volts
Peak plate current 500 max. ma.
D.C. output current 85 max. ma.

*In half wave rectifier service, the two units of the 25Z6GT may be used separately or in parallel; ratings are per plate.

SERVICING QUESTIONS & ANSWERS

(Continued from page 667)

pass condensers and A.F.C. transformer on 3 different occasions. This set will kick up on the bench about once in every 4 hours and as soon as I reach for the bottom of the chassis the motorboating stops; put it back in the cabinet and in 5 minutes you have a 1st-class motorboat again. On one occasion replacing the 6B8G cured the trouble for about 3 weeks then back she came just the same as always. Also shoving the wires around under the chassis makes it play normally for days then comes the bump-bump again. I have heard this same noise in several other radio sets and nobody seems to know just what it is. The nearest approach to the sound is a grid leak, leaking slow at first, and then getting up speed enough to distort speech and music.

(A.) The motorboating condition as described in your letter is most likely caused by a "floating shield," or ground. Check the mounting lugs, nuts and rivets for each I.F. transformer, socket, shield, etc., and make certain that each is definitely grounded to chassis. Clean the base of each tube shield so that perfect contact is secured. Check all rivets and lugs by which connection to chassis is made.



...with an Augmented (bigger) Company of

Centralab

LOW CAPACITY LEVER ACTION SWITCHES

It's been a "sell out" from the very start . . . Now . . . augmented combinations cover every probable requirement you may have. The program (libretto) now lists the complete line-up. Just write and ask for special Bulletin No. 680 for full details, or see your jobber.

CENTRALAB
Div. of Globe Union, Inc., Milwaukee, Wis.



Contact clips of spring brass heavily plated (silver) treated for easy soldering. Switching combinations available use up to 12 clips per section.

Please Say That You Saw It in RADIO-CRAFT

NEW TEST OSCILLATOR FOR TELE-CRAFT

THIS ultra-highfrequency oscillator holds the distinctive position of being the first publicly-available oscillator capable of generating fundamental signals at frequencies from 22 to 150 megacycles at an overall accuracy of better than 2% in one continuous band. It is a reliable signal source for use in high-frequency police, aircraft and television fields. The latter application is extremely interesting in view of the present spasmodic television transmission schedule. Guesswork is eliminated from television receiver installations through the use of this equipment.

Quite naturally, this device in order to be capable of such performance must contain some radical departures in general design.

Adjusting any circuits to oscillate at 100 megacycles is in itself a problem but when in addition it is necessary to tune and retune such a circuit accurately innumerable problems present themselves. Most of those problems, however, center in the tuning condenser. The conventional air condenser has limited capacity ranges together with restricted temperature and humidity characteristics. In addition, it is found that such a part can no longer be considered as pure capacity for it is, to a certain extent, inductive at ultra-high frequencies. This inductance in shunt with the tube circuit materially reduces the Q of that combination.

The variable condenser tuning methods are limited in their coverage of high frequencies and it would, therefore, require a number of different condenser and coil combinations to cover the desired range.

For the above reasons, therefore, the usual tuning methods were cast aside in favor of the inductance tuning system. This

is a process whereby the inductance is rotated causing a bifurcated (split) "trolley" to follow the wire thus shorting out a portion of the coil. The contactor and unused portion of the coil remain at ground potential at all times and the high-frequency limit is established not by a trimmer condenser but rather by a separately adjusted inductance.

Using this inductance tuning method, (1) wide tuning ratios are obtainable along with good stability and resetability. The wide frequency range of 22 to 150 mega-

cycles direct-a necessary band spread. The oscillators are portable and batteries in order of field application 8 x 8 x 11 ins., w 16 lbs. Output is norm. short rod antenna, alt. output jacks are supplied junction with a resistance approximately 1/10th of a volt from the rod antenna, while voltage through the attenuator somewhere near 20 microvolts at frequencies with a coverage of approximately +20 db. above this value available.

A type 955 ("acorn") oscillator tube operates with 400-cycle modulation supplied by a type 30 tube if desired. Provisions are also available for a quartz crystal, the modulator stage being converted to a crystal oscillator for zero-beat calibration of the unit when extreme accuracy is required. A small trimmer condenser appears on the panel for resonating this circuit.

A 6-position switch appears on the panel and serves the following functions. In position No. 1, the device functions as a C.W. oscillator under which conditions external modulation can be applied. The limits of the circuit for external modulation are rather broad so that it is possible to apply picture modulation for the purpose of running complete tests on television receivers and their associated antenna arrays. In position

(1) See "New Condenserless Tuning System Demonstrated," *Radio-Craft*, Feb. 1938.—Editor

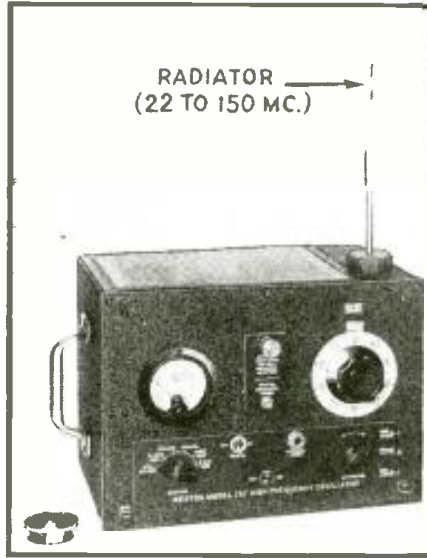

Latest Weston test oscillator for television.

OF THE SERVICEMAN, BY THE SERVICEMAN, FOR THE SERVICEMAN!

MAIL THIS COUPON!

RADIO SERVICEMEN OF AMERICA, INC.
304 S. Dearborn St., Chicago, Ill.

Gentlemen:

I hereby make application for membership in the Radio Servicemen of America.

Name

Address

City State

I am enclosing \$4.00 for Dues and Initiation.
(Does not include Local Chapter Dues where Local Chapters are organized.)

Yes . . . the RSA is yours, Mr. Serviceman! It's run by and for its members—uncontrolled by any outside interests. You elect your representatives (all responsible officers are bonded)—and they work for you!

Here is what RSA gives you: ★ Advanced Circuit Notes for Members each month. ★ Technical Help on Service Problems. ★ Access to its National Speakers Bureau. ★ Advanced Service Courses to Members at slight cost. ★ A Monthly RSA Publication. ★ Annual Convention. ★ And many other benefits now being planned.

Make progress this year by using your time to the best advantage. Send the Coupon Today—and be "in" with your fellow servicemen!

National Yearly Dues \$3.00
Initiation Fees \$1.00

Let's Grow Together in 1939

RADIO SERVICEMEN OF AMERICA, INC.

Joe Marty, Jr., Executive Secretary ★ 304 S. Dearborn Street, Chicago



Please Say That You Saw It in RADIO-CRAFT

RADIO-CRAFT for MAY, **FREE**



Now

You Can **ELECTROPLATE** Easily with a **BRUSH**

SOMETHING new for radio men—something which gives you the opportunity to make additional profits—or to improve your type of service. Here's an **ELECTROPLATING KIT** amazingly simple to operate—you just Electroplate with a Brush!

NOT A TOY!

You can electroplate for profit, hundreds of things in the household—ashttrays, fixtures, water faucets, worn brackets, door knobs, musical instruments, jewelry and silverware and other articles. It's an indispensable piece of equipment to you for plating articles in hotels, apartments, office buildings, medical and dental offices, factories, schools, laboratories, etc. Exactly the same outfit (but larger) is used professionally by electricians, radio service men, automobile repair shops, etc. Requires one single dry cell 1½-volt battery to operate.

And for radio work, you can electroplate tarnished receiver parts, escutcheons, contacts, worn radio parts and accessories, and display chassis. Put this **REAL ELECTROPLATING KIT** to use immediately—make it the most useful article in your shop or laboratory. And, you can get it absolutely **FREE** (except for slight mailing cost).

Send your subscription today to **RADIO-CRAFT** for One Year (12 issues) and receive absolutely **FREE** this **REAL ELECTROPLATING KIT**. New subscribers are accepted or you may extend your present subscription another twelve months under this offer. Mail your remittance of \$2.50 (plus 10c for shipping charge on kit) to the publishers of **RADIO-CRAFT** (Canada and foreign \$2.85). You will promptly receive your **FREE, REAL ELECTROPLATING OUTFIT** by return mail. Use the coupon below to order your subscription.

RADIO-CRAFT

99 Hudson Street New York, N. Y.

RADIO-CRAFT RC-539

99 Hudson Street, New York, N. Y.

Gentlemen: Enclosed you will find my remittance of \$2.50 for which enter my subscription to **RADIO-CRAFT** for One Year (12 Issues). Send me promptly my **FREE, REAL ELECTROPLATING OUTFIT** (Canada and foreign \$2.85). In U. S. add only 10c additional to cover shipping charges on kit.

New Subscriber Extend Present Subscription

Name

Address

City State

(Send remittance by check, money order or unused U. S. Postage stamps. Retest letter if you send cash or stamps.)

No. 2, 400-cycle modulation is applied to the signal at approximately 30% modulation.

Position No. 3 of the switch disconnects the internal "B" batteries permitting increased output through the use of external batteries of 180 volts. Position No. 4 converts the modulator tubes for use as a crystal oscillator. Positions No. 5 and No. 6 are used for checking the voltage of the battery supply. In all 6 positions of this switch a 2½ in. panel instrument indicates circuit conditions serving the double purpose of showing when the device is turned off or on.

We might prophesy that the inductance tuning system used in this test oscillator will be used in all future desirable types of high frequency equipment.

This article has been prepared from data supplied by courtesy of Weston Electrical Instrument Corp.

OPERATING NOTES

(Continued from page 667)

the 6,000-ohm cathode resistor (No. 12) can be replaced by a 4,000-ohm resistor and everything is OK. It is always advisable to alter the set after this change is made.

C. D. O'NEAL, Star Furniture Co.

FORD 1939 DE LUXE RADIO (PHILCO)

Distortion and practically no volume. Cause: open cathode resistor on 42-type tube.

Inoperative automatic tuning button. This radio set has a rather simple scheme on its automatic tuning. Selected stations are pre-tuned by trimmers and individual sets of these pre-tuned trimmers are coupled-in by a switching arrangement. By depressing a button (only one button is used to select all stations) a plunger in a strong electromagnetic field is engaged and the switch contacts are turned around to different combinations of trimmers for the various stations. I have encountered two types of trouble with this receiver:

(1) If the battery is weak the electromagnetic field around the plunger will be relatively weak and will not revolve the switch contacts to a proper new position. It may take 3 or 4 punches at the button on front panel to revolve the switch contacts one position (and each time button is pressed the station call letters on front change!).

Remedy: a hot battery for the car and a reset of call letters to correspond with their correct set of contacts. This is easily done by taking the eraser-end of a pencil and slipping the celluloid cylinder on which the station call letters are placed.

(2) Radio set will operate very poorly at full volume, but a bump in road may jar receiver a little and a station blasts in loud. This is caused by the coupling between plunger and switch not being synchronized properly. Each time the button is depressed the switch contacts are turned in between each other instead of together.

Remedy: Loosen set-screw in shaft that goes back to plunger, turn shaft a little and re-tighten at point that will synchronize contacts of switch. See diagram, Fig. 1.

M. F. CROWELL, JR.

P. A. Engineering Service

Last month Vocograph Sound Systems announced availability of a 24-hr. service on quotations and engineering specifications on all sound installations. Another announcement made at the same time, and one which is of exceptional interest to the Serviceman and to the sound specialist who wants to avail himself of every possible means of reducing sales resistance, was that this sound equipment manufacturer is also offering free to sound men letterheads, business cards and window signs as part of a new direct factory franchise.

Please Say That You Saw It in **RADIO-CRAFT**

★ ★ ★ ★ ★ ★ ★ ★ ★ ★ ★ ★ ★ ★ ★ ★
GREATER VALUE ★
 In the **RCP** ★
Dynoptimum Tube Tester ★
 ★ ★ ★ ★ ★ ★ ★ ★ ★ ★ ★ ★ ★ ★ ★ ★



MODEL 307

SEE this remarkable instrument at your local jobber and convince yourself of the "GREATER VALUE" in this and other RCP UNITS.

Tests ALL tubes, including Loctals, OZ 4, cold cathode rectifiers, metal and glass. Tests ballast tubes. Hot interelement short and leakage check. Hot cathode leakage test. Tests each section of rectifiers and all multi-purpose tubes. Line voltage indicator on meter. Other features in catalog. Send for your copy TODAY!

Combination portable and counter model (Model 307P), at the low cost of \$18.95. Also Model 307 complete, your cost only **\$16.95**

Have you seen the new Model 411 Supertester? An outstanding value at \$16.95. 5 stage AC-DC voltage range to 5,000 volts. Current range to 25 amps. Many other desirable features. Available at all leading distributors. Send for catalog today.

ALL RCP INSTRUMENTS ARE COMPLETELY EQUIPPED FOR TESTING LOCTAL TUBES.

RADIO CITY Products Co.
 88 PARK PLACE NEW YORK CITY

YOU CAN BECOME A MONEY-MAKING RADIO EXPERT

WITH THE **New SPRAYBERRY**
 Personalized **HOME TRAINING in RADIO**

You Learn Easily in Your Spare Hours
 By Doing Many Experiments with Up-To-Date Equipment

Here's a really fine, up-to-the-minute Radio and Television Training that's specially designed to give you quick results. **TRAINING PREPARES YOU FOR GOOD RADIO JOBS . . . AT EXCELLENT PAY.** My training starts right at the beginning of Radio . . . unfolds each subject in a simplified, logical, understandable style. You easily learn Television, Electronics, Facsimile Radio, Radio Set Repair and Installation Work, etc.

NO PREVIOUS EXPERIENCE NEEDED It makes no difference what your education has been. I can fit you for a good paying Radio job. Your success is my full responsibility.

YOU GET PROFESSIONAL TEST EQUIPMENT PLUS EXPERIMENTAL OUTFITS

Includes 115 Radio Parts (to build complete Receiver), Tools, All Wave, All-Purpose Analyzer, and Experimental Outfits for conducting actual experiments with your own hands.

I Supply My **BUSINESS BUILDERS** show you how to put your equipment to practical use in handling actual money-making Radio Service Jobs shortly, after you begin training.

SERVICEMEN I offer Advanced Training for those already in Radio. Get complete details in my **FREE 52-page Book**. *The Sprayberry Course* is Sold Under a Money-back Agreement.

RUSH COUPON for BIG FREE BOOK

SPRAYBERRY ACADEMY OF RADIO
 F. L. Sprayberry, Pres.
 220-E University Place, N. W.,
 Washington, D. C.

Please send me **FREE** copy of "HOW TO MAKE MONEY IN RADIO."

Name Age

Address State

City State
 Tear off this coupon, mail in envelope or paste on reply postcard. Servicemen—Check here ☐

FOUR NEW 10¢ RADIO

CRAFT For MAY, 1939

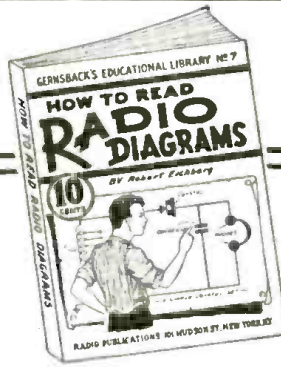
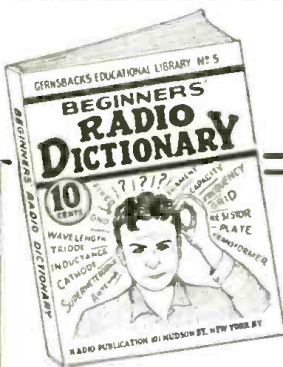

RADIO FANS EVERYWHERE—these little ten cent text books give you an excellent foundation for the study of radio. They are clearly written, profusely illustrated and contain over 15,000 words in each book. You'll be amazed at the wealth of information these volumes have. They are handy for review or reference books.

NO. 5—BEGINNERS' RADIO DICTIONARY

Are you puzzled by radio language? Can you define frequency? Kilocycle? Totrode? Screen Grid? Baffle? If you cannot define these very common radio words and dozens of other, more technical, terms used in all radio magazines and instruction books, you need this book in your library. It's as modern as tomorrow—right up to the minute. It tells you in simple language just what the words that puzzle you really mean. You cannot fully understand the articles you read unless you know what radio terms mean. This is the book that explains the meanings to you. Can you afford to be without it, even one day longer?

NO. 6—HOW TO HAVE FUN WITH RADIO

Stunts for parties, practical jokes, scientific experiments and other amusements which can be done with your radio set are explained in this fascinating volume. It tells how to make a newspaper talk—how to produce silent music—how to make a "silent radio" unit, usable by the deafened—how to make toys which dance to radio music—sixteen clever and amusing stunts in all. Any of these can be done by the novice, and most of them require no more equipment than can be found in the average home. Endless hours of added entertainment will be yours if you follow the instructions given in this lavishly illustrated book.

NO. 7—HOW TO READ RADIO DIAGRAMS

All of the symbols commonly used in radio diagrams are presented in this book, together with pictures of the apparatus they represent and explanations giving an easy method to memorize them. This book, by Robert Eichberg, the well-known radio writer and member of the editorial staff of RADIO-CRAFT magazine, also contains two dozen picture wiring diagrams and two dozen schematic diagrams of simple radio sets that you can build. Every diagram is completely explained in language which is easily understood by the radio beginner. More advanced radio men will be interested in learning the derivation of diagrams, and the many other interesting facts which this book contains.

NO. 8—RADIO FOR BEGINNERS

Hugo Gernsback, the internationally famous radio pioneer, author and editor, whose famous magazines, RADIO AND TELEVISION and RADIO-CRAFT are read by millions, scores another triumph with this new book. Any beginner who reads it will get a thorough ground work in radio theory, clearly explained in simple language, and through the use of many illustrations. Analogies are used to make the mysteries of radio as clear as "2+2 is 4". It also contains diagrams and instructions for building simple radio sets, suitable for the novice. If you want to know how transmitters and receivers work, how radio waves traverse space, and other interesting facts about this modern means of communication, this is the book for you!

Other Titles in This 10c Book Series!

- No. 1—HOW TO BUILD 4 DOERLE SHORT-WAVE SETS
- No. 2—HOW TO MAKE THE MOST POPULAR ALL-WAVE 1- AND 2-TUBE RECEIVERS.
- No. 3—ALTERNATING CURRENT FOR BEGINNERS
- No. 4—ALL ABOUT AERIALS

Four other volumes in this ten-cent radio book series—each on a popular subject—are available. The titles are:

RADIO PUBLICATIONS, Dept. RC-539
101 HUDSON STREET, NEW YORK, N. Y.

Gentlemen: Please send immediately, POSTPAID, the book numbers circled below. I am enclosing cents—each book being 10c.

Send FREE listing of 48 new 10c publications.

Name

Address

City State

Remit by check or money order—register letter if you send cash or unused U. S. postage stamps.

MAIL COUPON TODAY!

BOOKS ARE ALL UNIFORM

Every book in the GERNSBACK EDUCATIONAL LIBRARY has 32 pages—with illustrations varying from 30 to 66 in number. Each title-volume contains over 15,000 words. Positively radio's greatest book buy! If you do not think these books worth the price asked, return them in 24 hours and your money will be instantly refunded.

RADIO PUBLICATIONS
101 Hudson Street New York, N. Y.

THE RADIO MONTH IN REVIEW

(Continued from page 647)

camel's-hair) hypothetically woven with a fine wire that carries heat, generated by condensed batteries housed in the battery pockets on the front of the coat.

"Even though the world of tomorrow is universally air-conditioned, there will probably be a personal preference for good old-fashioned outdoor air, and this coat will permit our future sissified systems to take it without pain. With this coat, the wearer may use an open sports car or plane and plug the heat contact into a provision in the car."

These designers, and 5 others in the group, are now occupied at the N. Y. Fair where their "World of Tomorrow" fashion forecasts for *Vogue* will be displayed.

RADIODDITY

When the German-American Bund held its annual meeting at Madison Square Garden in New York, last month, the assemblage around 49th St. was suddenly startled to hear a voice advising the crowd to go home, followed by the music, "The Star Spangled Banner." Police found an ingenious apparatus, including a phonograph-record player and a timing mechanism, playing by itself in a darkened room in an apartment building. They turned it off and set about tracing 2 men who had hired the room the day before.

BROADCASTING

UNCLE SAM was scheduled last month to lose his No. 1 position in the broadcast field; no longer will he have the world's most powerful broadcast transmitter. Effective March 1, the F.C.C. ordered WLW, Cincinnati, to stop pushing out 500,000-watt programs and get in line with the other boys that are more or less content with 50,000-watt ratings. Moscow, RV-1, now becomes cock-of-the-walk. The United States Court of Appeals (D. of C.) has refused WLW a stay of the F.F.C.'s order.

Station W6XBE—on the Golden Gate International Exposition's Treasure Island, in San Francisco Bay—by means of new directional antennas will have a station power "equal to 200,000 W. and it will shut out all interference from foreign stations," according to a release of last month. Continued the release. "When broadcasting to the Far East, the station will 'blanket' Japan, China, Siberia, India, Siam, the Philippines and a portion of Australia. When broadcasting to Latin America it will 'blanket' Mexico and all of Central and South America."

When Chile was devastated by an earthquake that resulted in the death of about

2,000 persons, last month, the aid of radio was solicited.

Broadcasts by the Ministry of Interior were made to the people of Talca and Chillan to prepare emergency landing fields for relief planes.

Also, the Ministry appealed to motor car owners all over the country to lend batteries to amateurs, so that radio stations could be reopened.

A bill introduced in the Utah Senate, last month, proposes a \$50,000 appropriation to finance study of a plan to substitute radio instruction for classroom instruction of children in the 5 lower grades.

Sponsors said the plan would reduce teaching costs, protect children from hazards of travel and from exposure to disease, and would provide uniform instruction, according to an A.P. report.

Station WMCA, under the call letters W2XQO, is now investigating the characteristics of the 11-meter band as an ultra-high frequency channel.

According to Frank Marx, chief of the WMCA engineering staff, the tests to date indicate not only an almost total absence of natural static but also a high degree of line-of-sight transmission as well as distant reception. A 100-W. transmitter is used with coaxial feed to the antenna atop the 300-ft. WMCA tower. Since most broadcast receivers are not equipped for 11-meter reception, states WMCA, the station is offering information on the construction or purchase of simple converters.

Please Say That You Saw It in RADIO-CRAFT

OPPORTUNITY AD-LETS

Advertisements in this section cost five cents a word for each insertion. Name, address and initials must be included at the above rate. Cash should accompany all classified advertisements unless placed by an accredited advertising agency. No advertisement for less than ten words accepted. Ten percent discount for six issues, twenty percent for twelve issues. Objectionable or misleading advertisements not accepted. Advertisements for June, 1939, issue must reach us not later than April 7th.

Radio-Craft • 99 Hudson St. • New York, N. Y.

AGENTS WANTED

300% PROFIT SELLING GOLD LEAF LETTERS FOR store windows; Free samples. Metallic Company, 451 North Clark, Chicago.

GET UNSEEN, UNBELIEVABLE, THRILLING SEN- sational Eastern novelties. Samples 50c. Motiwalla Bros., Third Bhowada, 38V, Bombay, 2, India.

AMPLIFIER DIAGRAMS

10 MODERN CIRCUITS OF 8 TO 64 WATT EASY- to-build high-fidelity amplifiers. All for 10c. Send coin or stamps. Amplifier Company of America, 17 West 20th Street, New York City, N. Y.

BOOKS AND MAGAZINES

WE HAVE A FEW HUNDRED RADIO ENCYCLO- pedias, by S. Gernsback, second edition, originally sold at \$3.98. Book has 352 pages, weight 3 lbs., size 9 x 12 inches. Best morocco-keratin flexible binding. Send \$2.49 in stamps, cash or money order and book will be forwarded express collect. Technifax, 558 W. Washington Blvd., Chicago, Illinois.

BUSINESS OPPORTUNITY

RECEIVE STACKS MAIL OPPORTUNITIES GALORE. magazines, samples. Your name listed 5,000 directories 10c—15,000, 25c. Wilsons, 2408 Pine, Everett, Washington.

CAMERAS & SUPPLIES

AMBERTINT 16MM. CAMERA FILM. \$1.85 FOR 100 feet, including machine processing. Daylight loading Weston Eight. Nonhalation. Two rolls \$3.50. Order now. Hollywood Studios, Southgate, Calif.

GENERA FILM—ALL MOVIE CAMERAS. 100 FEET 8 mm. \$1.00; double, \$1.75; 16mm. \$1.35. Sample for stamp. Processing Powders, Outfits, Fromaders, Davenport, Iowa.

COINS AND STAMPS

STAMP COLLECTORS—INTRODUCTORY OFFERING— 103 stamps including scarce BI-colored Diamond and Triangular shaped Commemoratives—10c. Approvals. Friendly Philatelists, Box No. 4428R, Philadelphia, Penna.

FREE! JUBILEES, CORONATIONS AND AIR MAILS. Postage and backing 10c. National Parks Stamp Shop, Malden, Mass.

EDUCATIONAL COURSES

USED CORRESPONDENCE COURSES AND TECHNICAL books, bought, sold, rented, exchanged. Catalog free. Vernon's Exchange, Henshaw, Alabama.

USED CORRESPONDENCE COURSES AND RADIO service manuals—bought, sold, rented. State your wants. Educational Exchange Company, Box 37, Ft. Payne, Ala.

FOR INVENTORS

CASH FOR UNPATENTED IDEAS. STAMP APPRE- ciated. Mr. Ball, 8441-J Pleasant, Chicago.

MISCELLANEOUS

ANALYZE YOUR OWN HANDWRITING OR FRIEND'S. Chart 25c. Ing, 126 S. Center, Stockton, Calif.

MEXICAN DIVORCES: NO PUBLICITY. AMERICAN attorney, Box 1736, El Paso, Texas.

PYRO PANTAGRAPH—THIS ELECTRICAL OUTFIT burns designs permanently on leather, wood, cork, gourds, bakelite, etc. Simply plug pyro electric pencil into any 110 V. A.C. or D.C. line and it is ready to use. Reduce or enlarge any design with special pantagraph included. Complete kit and instructions, \$2.75. (Add postage for shipping 3 lbs.) Wellworth Trading Company, 540 W. West Washington Street, Chicago, Illinois.

MONUMENTS & TOMBSTONES

GENUINE MARBLE, GRANITE. FREIGHT PAID. Catalog free. \$11 up. United States Marble & Granite Co. A-27, Oneco, Fla.

OFFICE SUPPLIES

2,000 NEATLY PRINTED BUSINESS OR SOCIAL cards, \$1.50. Printco, Box 823, Huntington, W. Va.

RADIO

SPEAKER FIELD, MAGNETIC, RELAY AND SOLENOID coils made to specifications. Single or large lot orders. Also rewinding. Nothelfer Winding Laboratories, P. O. Box 415, Trenton, New Jersey.

WE BUY AND SELL USED RADIO TESTING EQUIP- ment. Time payments if desired. Harold Davis, Inc., Jackson, Miss.

SONG POEM WRITERS

SONGWRITERS! MELODY FOR WORDS \$1.00. Little, 215 Mason Theatre, Los Angeles, California.

\$4,000 P. A. CONTEST

(Continued from page 648)

installation and to emphasize the fact that ANY radio man can engage in this profitable activity, Radio-Craft has instituted this contest.

There are no strings attached—anyone with the ability to make a public-address installation is eligible. The contest rules are explained below.

Radio-Craft feels that many individuals and organizations have made public-address installations introducing equipment or set-up innovations, or employing P.A. apparatus which meet entirely new and novel conditions; or other worthwhile P.A. installations. Therefore, in order to give our readers first-hand information we plan to run a series of articles based on the winning entries of this contest.

In order that these may be the cream of public-address installation articles, valuable awards will be given each month, for four (4) consecutive months. These awards will be made available through the co-operation of well-known manufacturers of public address and sound equipment.

Therefore, every Serviceman, dealer, public-address specialist or group of specialists capable of making what may be considered a worthwhile public-address installation will find it profitable to enter this contest.

Contest Rules

Section No. 1 (May)

- (1) Write a letter of not more than five hundred (500) words, exclusive of list of components, describing in detail a practical public-address installation. Give the date when the order was received.
- (2) Outline in the letter the business angle of the deal:
 - (A) How and where you got the lead, how you followed it up, and how you clinched the sale.
 - (B) Cost of apparatus, sale price, profit involved. In fact, give all the details which will guide other men in the radio field in undertaking similar work.
- (3) Outline the technical angle of the deal:
 - (A) Purpose of installation.
 - (B) Technical problems involved.
 - (C) Choice of equipment and reasons for use of same.
 - (D) How installation problems were solved.
- (4) Letters will be judged strictly on the merits of the installation jobs, i.e.: the choice of properly-rated equipment for the particular service to be rendered, ingenuity in solving installation problems, also initiative and business ability displayed in consummating the deal. Literary style or manner of presentation will not be considered.
- (5) Photographs and diagrams, although not requisite to this contest, are desirable and shall be considered as a permissible influence upon the judges.
- (6) All letters, photographs or diagrams submitted become the property of Radio-Craft. None can be returned.
- (7) This contest is not open to the officials or employees of Radio-Craft Magazine nor to any officials or employees of the companies submitting prizes for this contest.
- (8) The final closing date of this contest is midnight August 10th, 1939. All letters entered in this contest must be addressed to the PUBLIC ADDRESS CONTEST EDITOR, RADIO-CRAFT Magazine, 99 Hudson Street, New York, (Continued on following page)



Yes, yours for the asking. Whether you build or buy, you need this amazing catalog. Brand new, up-to-the-minute and crowded to the covers with important savings in radio. Not just a scattering of bargains to deceive you, but page after page of genuine values — all nationally advertised parts, tubes, build-your-own kits and test equipment — the remarkable Lafayette line of receivers, significantly rated "best buys" by consumer groups — new P.A. streamlined for Sell — and on everything you buy, prices consistently lower. It's a grand guide to savings this book. Tear off coupon and mail at once for your FREE copy of catalog 76.

LAFAYETTE RADIO CORP.
AND WHOLESALE RADIO SERVICE CO. INC.
NEW YORK, N. Y. • CHICAGO, ILL. • ATLANTA, GA.
100 SIXTH AVENUE • 101 W. JACKSON BLVD. • 246 REACHES ST.
BOSTON, MASS. • BIRMINGHAM, ALA. • NEWARK, N. J. • JAMAICA, L. I.

Rush New FREE Radio Catalog No. 76.

Name _____ PLEASE PRINT
Address _____
City _____ State _____

LAFAYETTE RADIO CORP.
Dept. 3E9—100 Sixth Ave., New York, N. Y.

PASTE COUPON ON PENNY POSTCARD

RADIO Simplified!
with Ghirardi's Home-Training Course
COMPLETE IN 7 BIG BOOKS

Every Phase of Radio, Electricity, Television, Sound and Cathode-Ray Tubes is made crystal-clear by A. A. Ghirardi in this fascinating self-instruction course. Here at last is your practical Training for Radio all in 1 big, handy, inexpensive book—compact and complete. That's why it's the most popular radio text in the world!

QUICK and EASY
Let Ghirardi prove to you how simple it is to master the fundamentals of radio quickly, so easy to understand it reads like "A.B.C."

36 Volumes in 1—972 pp.—508 illus.

1. Radio Broadcasting System. 2. Sound, Speech, Music. 3. Electron Theory; Elec. Current. 4. Elec. Units; Ohm's Law; Resistance. 5. Elec. Circuits; Batteries. 6. Magnetism. 7. Electromagnetism. 8. Electromagnetic Induction. 9. Inductance. 10. Capacitance. Condensers. 11. A. C. Circuits. 12. Filters. 13. Measuring Instruments. 14. Radio Waves. 15. Broadcasting. 16. Receiving. 17. Vacuum Tube Principles. 18. Vacuum Tube Characteristics. 19. Vacuum Tube Construction. 20. Vacuum Tube Detector and Amplifier Action. 21. Radio Frequency Amplification. 22. "Superhets". 23. R.F. Amplifiers; Tuning Coils. 24. Audio Amplifiers. 25. Speakers. 26. Battery-operated Receivers. 27. Power-Supply Units. 28. Elec. Receivers. 29. Automobile and Aircraft Radio. 30. Radio Facilities; Sound Systems. 31. Short-Wave. 32. Photoelectric Cells; Cathode-Ray Tubes. 33. Television. 34. Antennas and Grounds. 35. Testing; Servicing. 36. Sound Films. 856 Self-Review Questions!

USE IT 5 DAYS—OUR RISK!
Our money-back guarantee protects you 100%. So there's no need to postpone your radio training another day! Clip and mail the coupon—right now!

"MAIL COUPON TODAY"
RADIO & TECHNICAL PUBLISHING CO.,
45 Astor Place, New York, Dept. RC-59
 Here is my \$4. Please send RADIO PHYSICS COURSE postpaid, with money-back guarantee.

NAME _____
ADDRESS _____
CITY _____ STATE _____
 Send free descriptive literature.

Please Say That You Saw It in RADIO-CRAFT

QUALITY VALUE—GUARANTEE!

WESTINGHOUSE POWER GENERATOR

Manufactured for U. S. Signal Corps

A. C. ELECTRICAL POWER
 from a Windmill, from available Waterpower, from your Bicycle, Automobile, from your Motorcycle, from your Radio Trans-Footpedals or Handcrank (for transportable Radio Transmitters, Strong Floodlights, Advertising Signs); operate two generators in series to get 200 V. AC, obtain two phase and three phase AC, etc., etc.

There Are Over 25 Applications
 Some of which are:
 A.C. Dynamo lighting from eight to ten 20 Watt 110 Volt lamps, Short Wave Transmitter supplying 110 Volts AC for operating "Ham" transmitter on motor boats, Public Address Systems, Electric Signs on "river" yachts, etc. Camp Lighting, Short Wave artificial lighting apparatus, Television, Pelton Waterwheel for lighting strong search lights or electric signs, Airplane: for lighting work, etc., or other purposes. Airplane: for lighting work, etc., etc. 1/4 to 1/2 H.P. needed to run generator.
 Generator, as described, including 24E \$7.90
 PRINT 22 x 28 in. and Four-Page 8 1/2 x 12 in. INSTRUCTION SHEETS
 Send \$2.00 deposit balance C.O.D. Shipping weight 18 lbs.

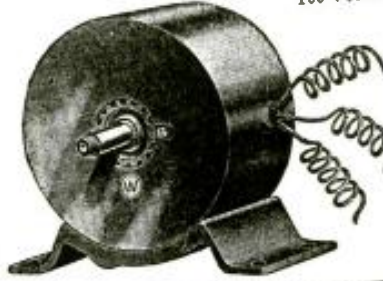

200 Watt.
100 V. AC

WESTINGHOUSE UNIVERSAL MOTOR



\$2.55

110 Volts AC and DC
Shipping Weight 3 lbs.

Specifications: 1/30 H.P. operates on either A.C. or D.C. used to vary speed. Height 3 1/2" stat. cap. 1" shaft 1/2" one inch length 3/8" width 1 1/2" Models: Buffing, Lathe, Drills, Grindstones, etc., etc.
 MOTOR only \$2.55
 MOTOR with Arbor and 1/2" Chuck \$3.55
 Add 25c for special packing and mailing anywhere in U. S. A.

G. E. PHONOGRAPH MOTOR

Formerly Sold for \$15.00



\$ ONLY 4.95

Variable speed induction type self-starting, 110 volt, 25 to 60 cycle, A.C. with speed control, plug be installed in place of old-fashioned hand-wind-and-a hundred other uses. These General Electric Motors have never been used and come four packed in original carton. G. E. Electric Phonograph motor as described (with-out turntable) \$4.95
 Shipping Weight—12 lbs.

ALL OUR MERCHANDISE IS UNUSED AND SOLD ON A MONEY-BACK GUARANTEE

MICROPHONE AND RECEIVER

This Microphone and telephone headset outfit was built especially for the U. S. Navy Aviation Corps, the outfit is Government specifications.
 The outfit consists of a low-impedance carbon microphone (transmitter), securely fastened to a impedance breastplate and a set of heavy-duty, low-impedance earphones. A specially constructed Utah type, attached to adjustable controls. Twenty-eight feet of very heavy weather and waterproof conductor cable is furnished. Current of not more than 10 volts should be used. A storage battery is the most satisfactory current supply.
 U. S. Navy Airplane-type Microphone and Receiver as described \$4.96
 Shipping Weight—0 lbs.

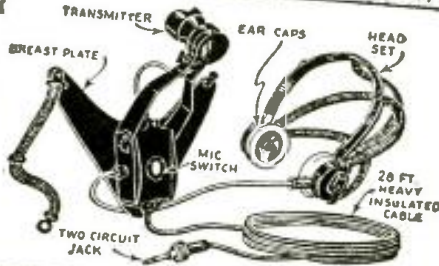

WELLWORTH TRADING CO.
 Dept. RC-539
 560 W. WASHINGTON BLVD., CHICAGO, ILL.

★ ORDER DIRECTLY FROM THIS ADVERTISEMENT ★
 WE SHIP 24 HOURS AFTER RECEIPT OF YOUR ORDER, BY EXPRESS COLLECT OR PARCEL POST IF YOU INCLUDE SUFFICIENT POSTAGE.

A CHANDELIER SPEAKER BAFFLE

(Continued from page 666)

mounted on a flat baffle of similar dimensions. This increase in efficiency is due in part to the exponential cavity created at the speaker unit mouth, inasmuch as this increases the acoustic impedance together with additional, increased airloading on the diaphragm, thus accentuating the two extreme ends of the audio spectrum.

USE OF MICROPHONES

Due consideration must be given to the choice of a microphone for use in conjunction with this reproducer. The nondirectional characteristics of this unit may introduce an appreciable amount of reflection if operated in a small room at high levels

and it will be necessary to make use of a directional type of microphone preferably with a lineal output.

This article has been prepared from data supplied by courtesy of Atlas Sound Corp.

FOOTPEDAL VOLUME CONTROL (1755) (Amperite Co.)

VERY smooth and easily controlled crescendos can be obtained with the new model FK footpedal control. It can be used with any of high-impedance crystal microphones (including the Kontakt) for musical instruments. The volume can also be set to any point and the foot removed.

Since the control is wired as a "T" pad, any number up to 5 can be used in parallel and fed into one input. When used in parallel any of the controls can be varied without affecting the other.

Please Say That You Saw It in RADIO-CRAFT

\$4,000 P. A. CONTEST

(Continued from preceding page)

N. Y., and must bear the postal cancellation stamp not later than midnight, August 10th, 1939.

- (9) Section No. 1 of this contest opens April 11th and closes midnight May 10th; Section No. 2, to be announced in the June issue, opens May 11th and closes June 10th; Section No. 3, to be announced in the July issue, opens June 11th and closes July 10th; Section No. 4, to be announced in the August issue, opens July 11th and closes August 10th. Postmarked dates will be considered conclusive.
- (10) A board of judges will decide the winners and their decisions are final.
- (11) THE JUDGES FOR THIS MONTH'S CONTEST
 George Brodsky of Allied Radio Corp.
 A. C. Shaney of Amplifier Company of America
 Leonard Werner of Amplitone Products Co.
- (12) A complete list of winners of Section No. 1 (May-issue contestants) will appear in the August, 1939 issue. Winners of Section No. 2 (June-issue contestants) will appear in the September, 1939 issue. Winners of Section No. 3 (July-issue contestants) will appear in the October, 1939 issue. Winners of Section No. 4 (August-issue contestants) will appear in the November, 1939 issue.

List of Prizes

(Continued from page 648)

- Auto-Top Carrier for Mobile Sound Installations, Platform Size, 30 x 36 ins. type PA22, \$16.00
 Offered by Vac-O-Grip Company
- 2 THIRTEENTH PRIZES—Jensen P.M. Dynamic Speaker, type PM-12, \$13.00
 Offered by Allied Radio Corporation
 "Chandelier" Baffle with Speaker Unit, type S-360, \$12.50
 Offered by Atlas Sound Corporation
- 2 FOURTEENTH PRIZES—Floor-Type Chrome Microphone Stand, model EF-17, \$12.50
 Offered by Eastern Mike-Stand Company
 Floor-Type Chrome Microphone Stand, model EF-17, \$12.50
 Offered by Eastern Mike-Stand Company
- 3 FIFTEENTH PRIZES—Desk-Type Microphone stand, type ED-127, \$3.75
 Offered by Eastern Mike-Stand Company
 Desk-Type Microphone Stand, type ED-127, \$3.75
 Offered by Eastern Mike-Stand Company
 Desk-Type Microphone Stand, type ED-127, \$3.75
 Offered by Eastern Mike-Stand Company

THE LATEST RADIO EQUIPMENT

(Continued from page 671)

AUTOMATIC BLOWTORCH FOR RADIO WORK (1754)

(Baumgarth Manufacturing Co.)

ILLUSTRATED is a new "pumpless" blowtorch of unique design. It combines many features and advantages which make it decidedly useful in radio work. No pumping is necessary to start it. Upon priming, the pump automatically develops its own pressure and "blows" as soon as the needle valve is open. The torch tilts to any angle and burns efficiently in any position. Its fuel capacity is 6 fluid ozs. affording a burning time of 4 hours. The flame temperature is claimed to be 2,400 degrees. The spherical brass tank which affords considerable safety to the high pressures developed is chromium plated. The torch is supplied with a steel base fitted with rubber-friction plugs for holding the torch at any angle.

RADIO TRADE DIGEST

RADIO MFRS. ENTERING OTHER ACTIVE FIELDS

(Continued from page 675)

"O" and "HO" gauge trains. The model railroad field is always open for quality accessories that do a real job.

Particularly interesting are these two new items, for some months ago RTD ran a summary of one of its questionnaires. This indicated that radio mfrs. might find new profits in non-radio lines; one of the lines suggested was photography, into which Weston and G-E had already entered.

The radio industry will watch with much interest to see whether DeJur and Ohmite will have the success it wishes them—and which their products have always merited.

ANNOUNCES NEW SOUND SYSTEMS

A complete line of de luxe sound systems for 1939 has just been announced by Vocagraph, of Chicago. Leader of the new line are the 40- & 100-watt jobs, listing at \$95 & \$150, respectively. Other models listed include those with outputs from 5 to 30 watts, portable systems, 6-volt D.C./110-volt A.C., and one including self-mounted turntable & pickup. Features this year are new colors, high-grade accessories, lower prices, and even better quality than ever before.

NATIONAL PROMOTION TO BOOST RADIO BIZ

(Continued from page 675)

plied to non-network stations so that all classes of stations may participate in the national campaign.

Another part of the all-radio project is the preparation of a simplified booklet detailing information on installation and use of receivers, and regarding programs and the American system of broadcasting. Inclusion of this pamphlet with each receiving set sold and otherwise distributed is planned.

The 4 main objectives of the RMA-NAB campaign are (1) to increase the amount of daily listening; (2) to increase the quality of home reception; (3) to sell the excellence, variety and extent of the American program schedule; and, (4) to sell the American system of broadcasting and contributions made thereto by each broadcast station.

In the promotion of school radio the RMA will cooperate with the Committee on Scientific Aids to Learning of the National Research Council of New York. Information is being collected regarding the quality and types of receiving sets best adapted for various school rooms and auditoriums. The RMA Engineering Department will prepare school receiver specifications for the National Research Council committee. These RMA specifications will be distributed to all school superintendents and educators.

The RMA Board of Directors also arranged for further cooperation with the Federal Communications' Commission regarding engineering standards for future experimental transmission of television, expected to begin this spring. Fourteen proposed standards for television transmission already have been submitted to the FCC by RMA, and two additional standards will be submitted soon. The RMA is preparing for early public hearings by the Commission on television standardization.

CARTER SAYS IT'S SO

(Continued from page 675)

ported by Stanley High in a Feb. 11 *Saturday Post* article, were given to High by Carter, insofar as they dealt with the Carter case. Carter also implied that McNinch, being so closely in the picture, might not be free from bias.

High accused the Government of indirect radio censorship; in the case of Carter, of bringing pressure to bear which resulted in his toning down anti-Administration talks with the result that he lost his listeners and finally his sponsorship. FC Commissioner McNinch's reply was in the *N. Y. Times* of the same date.

THE RSA MONTHLY BUGLE

(Continued from page 676)

office or vote; he must be a full-time Serviceman, have a business set-up, pay the different taxes imposed on one who is in business, have commercial phone listings, and pass a written and oral business and technical examination.

Duluth, Minn., Chapter: There was a discussion of plans, commencing with mediation with jobbers and continuing the "poor credit" lists of the Chapter. A scale of prices for auto-radio installation was made up.

Houston Chapter: To preserve tradition, the "President's Brief Case" case donated by J. L. Stone will be inscribed with the names of all past, and the newly-elected President in gold letters, in the order of their incumbency. This case will be passed on by each President, who will have his name inscribed thereon.

New Jersey Chapter: Mr. Miller, of Publicity, is working on a question and answer column in the *Newark Sunday Call*. Mr. Serra presented a design for a local membership card, to have the photograph of the member, and other identification and qualification data.

Springfield, Ill., Chapter: After each meeting, each member throws his odd pennies in a can. This is used for flowers for the sick, and small miscellaneous expenses.

A suggestion was adopted that each member stock certain types of special parts for the benefit of all, each drawing on the other fellow's stock as needed. The stock is to be built up as fast as the purse can stand it. In this way, everyone will have the advantage of a large stock of special parts without actually having to stock more than a portion of it. One member was assigned volume controls, another speaker cones, etc.

Washington, D. C., Chapter resolved to hold meetings every 2 weeks to instill the necessary interest in the new organization. Also that most local radio Servicemen were entirely oblivious to the pecuniary worth of their services and were undercharging their clients. There will be a thorough discussion of the possibility of standardizing service charges, with a probable cancellation of all offers of "free estimates" and "free service."

OLDEST VICTROLA CONTEST WINNERS AWARDED PRIZES

(Continued from page 676)

the year when each winning Victrola was built, follow:

1906, E. E. Forbes, Birmingham, Ala.; 1907, Lansdowne Electric Company, Philadelphia, Pa.; 1908, W. D. Murphy, Summit, N. J.; 1909 and 1910, Jenkins Music Company, Kansas City, Mo.; 1911, Petersen-Harned-Von Maur, Davenport, Ia.; 1912, Oklahoma Appliance Co., Shawnee, Okla.; 1913, John F. Domhoff, East St. Louis, Ill.; 1914, H. Royer Smith Co., Philadelphia, Pa.; 1915, Reynolds Helsing, Wahoo, Neb., and Monteen & Dolezal, Wahoo, Neb.

1916, The Wilson Music House, Maplewood, N. J.; 1917, the Seymour Shop, New Canaan, Conn.; 1918, The Foster Shop, Lafayette, Ind.; 1919, Market & Broad Radio-Music Co., Newark, N. J.; 1920, Cicero Radio Laboratory, Cicero, Ill.; 1921, Wurlitzer Co., Columbus, O.; 1922, Heim's Music Store, Inc., Danbury, Conn.; 1923, Checker Electric Supply Co., Cedar Rapids, Ia.; 1924, Spiros, Hicksville, N. Y.; 1925, Wurlitzer, Cincinnati, O.

Please Say That You Saw It in RADIO-CRAFT

The NEW 1939 RADOLEK



Everything in Radio

RADIO PROFIT GUIDE!

Everything in Radio—right in your copy of the RADOLEK PROFIT GUIDE. If you do not have a copy, send coupon NOW! When you order from Radolek you get just what you want promptly and economically. Over 25,000 Radio Servicemen and Dealers now depend on Radolek Service.

COMPLETE LINE OF RADIO SETS. A model for every purpose and purpose—from midsets to large phonograph combinations. Also auto radios, battery sets, new "Ham" receivers and transmitters are included.

NEWEST TEST INSTRUMENTS. The most complete line ever displayed in any catalogue. Latest models with newest designs.

OVER 12,000 REPAIR PARTS. Tools, Books, etc. All leading brands represented. Every item guaranteed! Also includes new items such as electrical appliances, shavers, electric clocks.

ALL TUBES. RCA, Sylvania, Raytheon, Philips, etc. Includes Kellogg, special Maelastic types and transmitting tubes. An R-100 tube data chart is found right in the Radolek Profit Guide!

Everything in Public Address

Radolek Public Address Systems are especially designed to fit every type of installation—permanent, portable or mobile.

COMPLETE SELECTION. Radolek offers a choice of 11 amplifier models and 21 models of complete P.A. systems. Outputs range from 3 watts to 100 watts. Radolek prices are the LOWEST. Send for the Profit Guide and Profit Now!

P.A. ACCESSORIES including speakers, baffles, cables, phono motors, pick-ups, microphones, stands and other equipment is shown in the Radolek Profit Guide.

Send for **FREE** Catalog

The RADOLEK Co.

601 W. Randolph, Chicago, Dept. C-29

Send the 1939 Radolek Radio Profit Guide FREE.

Name

Address

Serviceman? Dealer? Experimenter?

NEW

BOOK BY
RIDER

COMPLETELY
EXPLAINS



A Basic System of Servicing For ALL Communication Systems

A complete explanation of the system of servicing which many authorities believe will revolutionize present methods of locating defects in communication systems of all frequencies — transmitting or receiving. This system is fundamental, because it operates on the common denominator of all sets regardless of circuit—The SIGNAL! Because of this fact the book is also a veritable text book on radio receiver operation, for it discusses the functions of the various parts of all receivers—the paths of signal currents—the development of control voltages, etc. The book covers all modern receivers including television and facsimile.

300 pages, bound in hard \$2.00 covers. Out in April . . .

DID YOU SAY 9?

YOU NEED ALL 9
Rider
MANUALS

YES, I SAID 9!

JOHN F. RIDER, Publisher 404 FOURTH AVE. NEW YORK CITY

RADIO TRADE DIGEST

SNOOPS & SCOOPS

(Continued from page 677)

floor space? The boxes will be made under Conservador patents. . . The reason *Utah Radio Products Co.* didn't take over that new plant was that no agreement could be reached on price. . . *Philco* held its 1st natl. midwinter convention in Palm Beach, Fla., & disclosed plans for expansion; only the good-looking swbd. opr. was left in the Philly hdqtrs. to handle biz until gang got back.

Clarostat's busy with the new line of ferrule clip terminal type w-w resistors, & its new non-inductive power resistors, satisfactory up to 30 mc. . . The reason *Radio World* gives for the failure of its 2d issue under *Moore* management to come out on time is the death of *Roland Burke Hennessey*—who used to edit it before the new crew took over . . . *Chicago Sound Systems* have a new seller: record carrying cases that hold 45 or 100 10" records, former lists at \$3.50; latter, \$4.

SALES HELPS & DEALS

(Continued from page 677)

A 6-tube, 2-band set free was the bonus offer of *Midwest Radio Corp.* to purchasers of 12- or 17-tube models. The 2-for-the-price-of-1 offer used the appeal of the necessity for an extra set, which most homes require.

Live dealers cashed in on the ads of classical music programs presented over a leading N.Y. station. Their windows featured these ads with placards announcing "Same Records For Sale Here."

A choice of Precision instruments is being offered to dealers who buy *National Union* radio tubes. The more tubes, the more credits; the more credits, the more instruments.

\$'s & No.'s Dept.

(Continued from page 678)

all-time high record of 1937, although exports sharply improved during the last half of the year. *Radio* exports last December were the largest for any month in '38.

The record showed a decline of 30.8% in the number and 35.5% in the dollar volume of receiving sets shipped abroad. Decrease on tube shipments was 24.8% in units and 26.8% in dollar volume. Percentage decrease in component parts and accessories combined was 24.5%, while speaker exports decreased 15.8% in units and 23.4% in value. There was a decrease of only 3.8% in 1938 exports of transmitting apparatus.

TELEVISION TIPS

(Continued from page 678)

on a 4 x 6 foot screen to 1,000 guests at the N. Y. Patent Law Assn. banquet.

Unless telly biggies watch out, they may find themselves unable to xmit many events of major interest. While *RCA*, *Philco* & *Farnsworth* move majestically onward, fast-flying *Du Mont* group is reported by *Radio Daily* as making a *Wm. Morris* agency tie-up in addition to its *Paramount Pix* connection. Agency is stated to be signing colleges to rights for football & basketball games, track meets, etc.

Index to advertisers

A	
Aerovox Corporation.....	686
Alden Products Company.....	690
Allied Radio Corporation.....	687
Amperite Corporation.....	Inside Front Cover
Amplifier Co. of America.....	692
Amplitone Products Company.....	688
Arrow Sales Company.....	696
Atlas Sound Corporation.....	686
Auditorium Hotel.....	694
B	
The Brush Development Company.....	690
Burstein-Applebee Company.....	696
C	
Capitol Radio Engineering Inst.....	690
Central Radio Laboratories.....	697
Cinaudagraph Corporation.....	684
Classified Section.....	701
Cornell-Dubilier Corporation.....	695
Coyne Electrical School.....	643
Crosley Radio Corporation.....	693
D	
DX Radio Products Company.....	692
E	
Electronic Design Corp.....	679
H	
Hammarlund Mfg. Company.....	690
Howard Radio Corporation.....	682
Hygrade Sylvania Corporation.....	683
I	
Illinois Condenser Company.....	692
L	
Lafayette Radio Corporation.....	691, 701
Lancaster, Allwine & Rommel.....	696
Lincoln Engineering School.....	692
M	
Meissner Manufacturing Co.....	Back Cover
Miles Reproducer Company.....	692
Modell's.....	694
N	
National Plans Institute.....	684
National Radio Institute.....	641
National Schools.....	646
National Union Radio Corp.....	697
O	
D. W. Onan & Sons.....	684
R	
Radio & Technical Publishing Co.....	701
Radio Circular Company.....	692
Radio City Products Company.....	699
Radio Publications.....	700
Radio Servicemen of America, Inc.....	693
Radio Training Association.....	685
Rudolek Company.....	703
RCA Institutes, Inc.....	696
Readrite Meter Works.....	690
Remington Rand, Inc.....	694
John F. Rider.....	704
S	
Solar Manufacturing Co.....	693
Sprayberry Academy of Radio.....	699
Superior Instruments Company.....	680, 681
Supreme Instruments Corporation.....	685
T	
Technifax.....	696
Triplet Elect. Instrument Company.....	689
The Turner Company.....	688
U	
United Radio Company.....	692
W	
Wellworth Trading Company.....	702, 695
Weston Elect. Instrument Corp.....	Inside Back Cover
Wholesale Radio Service Co., Inc.....	701
Williams Philco, Inc.....	696
Wright-DeCoster, Inc.....	688

(While every precaution is taken to insure accuracy, we cannot guarantee against the possibility of an occasional change or omission in the preparation of this index.)

NOW

ULTRA HIGH FREQUENCY SIGNALS WHERE YOU WANT THEM

22 TO 150
MEGACYCLES

*24 hours
a day!*

WITH THE NEW WESTON Television ULTRA HIGH FREQUENCY OSCILLATOR

- Frequency—continuous range 22 to 150 mega-cycles—no band switching.
 - All frequencies fundamental.
 - High order of stability and resetability over entire range.
 - Equipped for television modulation.
 - Employs continuously variable inductive tuning.*
 - Equipped for use with crystals.
 - Battery operated (self contained).
 - Equipped with 400 cycle modulator.
 - Used with portable antenna (included) or with standard output leads.
 - Jack provided for external power to increase radiation.
 - Over 5700 degrees of continuous dial rotation.
 - Meter equipped, for six control measurements.
 - Small size, light weight, extreme portability.
- * Patents Pending



Essential for all branches of television, for police radio, aircraft, maintenance trucks, etc.



Model 772
5000 VOLT

TELEVISION AND RADIO ANALYZER
Sensitivity 20,000 ohms-per-volt.
Output impedance 100 megohms on top range.
Specially designed low-leakage jacks.
Breakdown voltage in accordance with AIEE safety standards... 11,000 volts.
Current readings down to 1/2 microampere.
NOTE—present owners of 20,000 ohms-per-volt analyzers can bring them up-to-date with the compact WESTON 5,000 volt Televerter... an inexpensive multiplying unit which fits the carrying case.



Model 669

VACUUM TUBE VOLTMETER—measures gain in video and sound amplifying channels—peak voltages in thyatron (saw-tooth) generators in oscillator circuits—grid potentials on cathode ray tubes—as well as other essential measurements in all sound receivers.

SEND COUPON
FOR
COMPLETE INFORMATION

Weston Electrical Instrument Corporation
599 Frelinghuysen Ave., Newark, N. J.

Send bulletin describing the Model 787 Ultra High Frequency Oscillator and other WESTON Instruments.

Name _____

Address _____

City _____ State _____

WANT A GOOD RECEIVER?

BUILD IT YOURSELF!

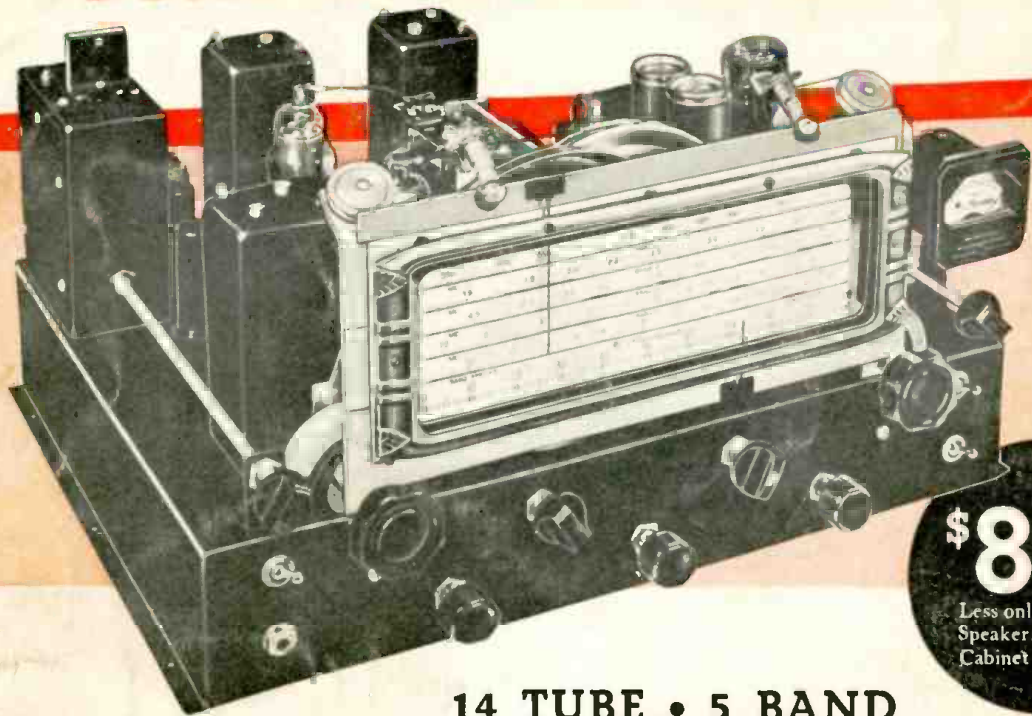

\$81.90

Less only Tubes and Speaker. Panels and Cabinet available.

14 TUBE • 5 BAND TRAFFIC MASTER Communications Receiver

A few evenings of fun with a screwdriver, a pair of pliers and a soldering iron—and you have a complete 14-tube communications receiver. And what a receiver! 5 bands covering the radio spectrum from 9.25 to 565 meters, from the 10 meter band to the top of the broadcast band. Every major improvement known to radio engineers. All the sensitivity and selectivity you can use, plus a high signal-to-noise ratio! Performance that even the finest commercial re-

ceivers can't beat!

The TRAFFIC MASTER comes to you complete (except tubes and speaker) in easy to assemble form, with its all-wave Tuning Unit, completely assembled, ready to mount. It's no job at all to assemble this unit with Meissner pictorial diagrams. See your parts jobber, or write today to Dept. RC-5, Mt. Carmel, Ill. for FREE 44-page catalog describing this and 21 other Meissner Kits.

AMATEURS—MAKE YOUR QSO's 100% WITH A MEISSNER SIGNAL SHIFTER

What an instrument. An electron-coupled Exciter Unit with almost unbelievable stability. Variable, too, so that you can cover any amateur band right from your operating position. Won't drift between QSO's! Removes the curse of QRM! Completely assembled except for tubes! Ask your Parts Jobber for demonstration, or write Dept. RC-5, Mt. Carmel, Ill. for full information.
NET PRICE only \$39.95



NEW! INFORMATIVE!

Packed full of valuable data, graphs, charts, pictorial diagrams, schematics, alignment data. Construction data on 21 Meissner Kits. Ask your Parts Jobber or write direct. Price 50c.



DEPT. RC-5

MT. CARMEL, ILLINOIS

"A FAMOUS NAME FOR TWO DECADES"